



Product Catalogue

2023

Journey



Yazibası Factory / Izmir

Growth is an
endless
journey
for us...

Established in 1996, Ege Home Products started its commercial activities with ironing boards, cloth dryers and step ladders. Over the years, the company has gained an advantage against its competitors thanking to its additional investments and production based on quality within a 75.000 m² closed area.

With the outcome of its investments and quality-oriented production mindset, Ege Home Products has become a leader and maintains its success both in national and international competitive market. The company makes an export to over 120 countries with its 26 years industrial experience and aims to continue its growth & success journey for many years.

Ege Home Products has a prioritized policy of providing a level of quality which meets our customers need and expectations within the scope of national and international standarts and legal regulations. While it maintains the sustainability it also completely fulfills all of its duties on awareness in environment and nature.

Providing the product in the desired manner can only be achieved by emphasizing creativity, innovation and R&D. In order to increase the effectiveness of the new product development process our Research and Development team consistently follows the latest houseware novelties within the context of modernization. We are reaching our targets with the awareness of continuous improvement by following the regulations of Quality Management System. With the power of customer demands, our company improves itself with fast, efficient and high-quality solutions for self-renewing and certified its quality level with GS; ISO 9001: 2015; TSE; ICS and BSCI.



Torbali Factory / Izmir

Export





Being proud
to be an
export leader
in the
sector...

Ege Ev Products holds its leadership in houseware field for many years with the strength of its 26 years experience in local and international market, thanks to its quality focus approach towards production and new investments.

Growth is an endless journey for the company which facilitates its operations within a 75.000 m² closed area, exporting to more than 120 countries.

Nature





Respectful to
nature
Sensitive to
nature...

Ege Home Products has a prioritized policy of providing a level of quality which meets our customers need and expectations within the scope of national and international standarts and legal regulations. While it maintains the sustainability it also completely fulfills all of its duties on awareness in environment and nature...

Quality





Good
quality
is never won
by chance...

In order to increase the effectiveness of the new product development process our Research and Development team consistently follows the latest houseware novelties within the context of modernization.

We are reaching our targets with the awareness of continuous improvement by following the regulations of Quality Management System.

Index

IRONING BOARDS	8-53	18336 SAMBA LUX	30
18326-20 DIAMOND SERIES	10	18367 ARES	31
18364-20 STONE SERIES	12	18369 ADA	32
18344-20 CITY SERIES	14	18355 DINAMIC	33
18328 MERIVA	16	18368 SERA	34
18327 MONO MONDO	17	18346 BONUS	35
18326 MONDO	18	18356 IDEAL	36
18324 JUMBO	19	18365 AQUA LUX	37
18323 VIVA	20	18349 AQUA 25	38
18320 PRESTIGE	21	18364 AQUA 21	39
18302 CARINO LUX	22	18366 DIAMOND	40
18348 SILVER	23	18347 POWER	41
18315 FOCUS	24	18343 BASIC	42
18318 DREAM	25	18344 BRAVA	43
18325 MAGIC	26	18358 ONE	44
18304 CAPITOL	27	18359 MINI ONE	45
18301 CARINO	28	18360 TABLE TOP	46
18340 ATOS	29	DETAILS	47

CLOTHES DRYERS **54-85**

18139 STREAM 4	56
18138 STREAM 3	57
18137 STREAM 2	58
18142 ISTANBUL LUX	59
18111 WINGS LUX	60
18111-01 HERO	61
18109 WINGS BODRUM	62
18124-01 FANTASY LUX	63
18124 FANTASY	64
18120-1 AEGEANSTAR LUX	65
18120 AEGEANSTAR	66
18121 STAR	67
18110 UNO	68
18133 FLEXY 220	69
18132 FLEXY 160	70
18130 COSMOS	71
18128 SMART	72

18117 FLORA	73
18116 HANDY	74
18105 CAPRI LUX	75
18101 CAPRI	76
18114 JUNIOR	77
18161 SMYRNA	78
18108 THINK	79
18143 LUNA	80
DETAILS	81
CAMPING ASSORTMENT	86-103
18680 SUNSHINE	88
18638 TITO	89
18658 RETRO	90
18645 SPORCO	91
18632 NARIO	92
18610 PALIO	93
18636 LUCCO	94
18618 DANTE	95

18622 PARMA	96
18626 PAPSYP	97
18668 FISHER	98
18660 GIAN	99
18664 TINO	100
DETAILS	101

OTHER PRODUCTS **104-112**

18502 SUPER MASTER 2	106
18503 SUPER MASTER 3	107
18504 SUPER MASTER 4	108
18001 LUCCA 1	109
18002 LUCCA 2	110
18003 LUCCA 3	111
DETAILS	112

Pruning Boards

Boards



Diamond Series



DIAMOND

SERIES

18326-20

- Automatic height adjustment from 69 to 97,5 cm
- Completely electrostatic stainless paint
- 42x125 cm mesh top ironing surface
 - Colored, bright, cotton cover
 - Using high quality foam under fabric
 - Iron support bar
 - Special iron rest with incombustible silicon fittings
 - Suitable for boiler steam ironing
- Electric cable and plug certified by CE
 - Special cable holder design to facilitate ironing
- Plastic foot caps that prevent slipping
 - Plastic part for a fashionable design
 - Warranty 2 years

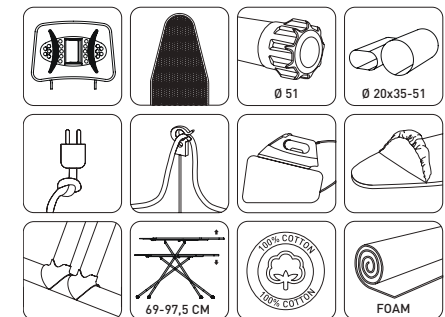

DIAMOND SERIES	 CM	 CM	 CM	 KG	 M ³	 Ø	 PCS	 CM	 M ³	 KG
18326-20	156x97,5x43	42x125	43x168	8,1	0,0567375	23x35-51	2	15x170x44,5	0,113475	16,5

Stone Scenery



STONE

SERIES 18364-20

- Automatic height adjustment from 66 to 92 cm
- Completely electrostatic stainless paint
 - 38x120 cm mesh top ironing surface
 - Colored, bright, cotton cover
 - Using high quality foam under fabric
 - Special iron rest with incombustible silicon fittings
- Plastic foot caps that prevent slipping
 - Warranty 2 years

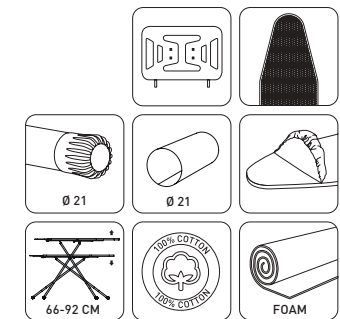

STONE SERIES	A CM B C	CM	CM	KG	M ³	Ø	PCS	CM	M ³	KG
18364-20	141x92x38	38x120	38x158	4,675	0,036455	21	2	11,5x158,5x40	0,07291	9,35

City Series







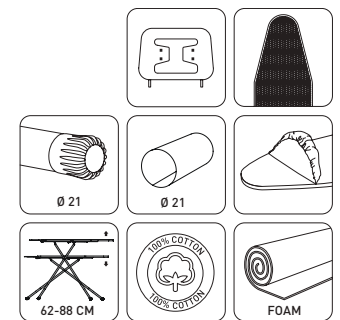

CITY

SERIES

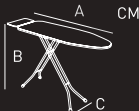
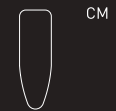
18344-20

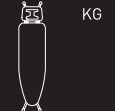
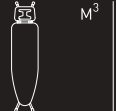
- Automatic height adjustment from 62 to 88 cm
- Completely electrostatic stainless paint
 - 33x110 cm mesh top ironing surface
 - Colored, bright, cotton cover
- Using high quality foam under fabric
 - Special iron rest with incombustible silicon fittings
- Plastic foot caps that prevent slipping
 - Warranty 2 years



CITY SERIES	 A CM B C	 CM	 CM	 KG	 M ³	 Ø	 PCS	 CM	 M ³	 KG
18344-20	130x88x34,5	33x110	34,5x146,5	3,85	0,022178625	21	4	17x147x35,5	0,0887145	15

MERIVA

18328



- Automatic height adjustment from 67 to 98 cm
 - Completely electrostatic stainless paint
 - 43x125 cm monoblock top ironing surface
 - Colored, bright, cotton cover
 - Using high quality felt under fabric
 - Suitable for boiler steam ironing
- Fireproof silicon metal ironing pad that can be removed for classic ironing use
- Electric cable and plug certified by CE
 - Special iron rest design for hanging ironed clothes
- Plastic foot caps that prevent slipping
 - Warranty 2 years

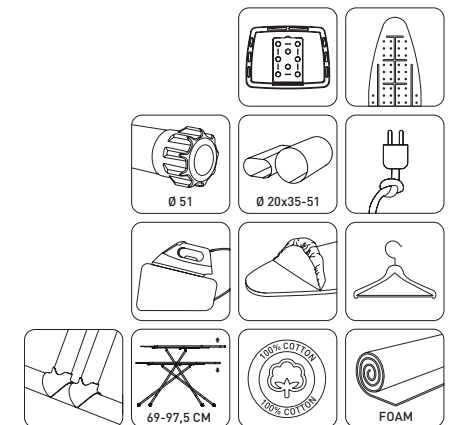

16

MERIVA



CM

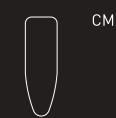

CM



CM



KG



M³

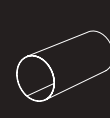

Ø



PCS



CM



M³



KG

18328

156x97,5x43

43x125

43x168

7,9

0,06241125

23x35-51

2

16,5x170x44,5

0,1248225

17,5

MONO MONDO

18327

- Automatic height adjustment from 69 to 97,5 cm
 - Completely electrostatic stainless paint
 - 43x125 cm monoblock top ironing surface
 - Colored, bright, cotton cover
 - Using high quality foam under fabric
 - Iron support bar
 - Special iron rest with incombustible silicon fittings
 - Suitable for boiler steam ironing
 - Electric cable and plug certified by CE
 - Special cable holder design to facilitate ironing
 - Plastic foot caps that prevent slipping
 - Warranty 2 years

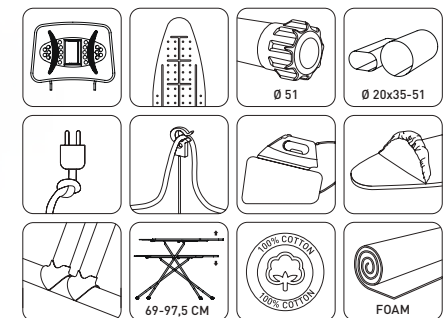

MONO MONDO										
18327	156x97,5x43	43x125	43x168	8,75	0,0567375	20x35-51	2	15x170x44,5	0,113475	18,3

MONDO

18326

- Automatic height adjustment from 69 to 97,5 cm
- Completely electrostatic stainless paint
 - 42x125 cm mesh top ironing surface
 - Colored, bright, cotton cover
 - Using high quality foam under fabric
 - Iron support bar
 - Special iron rest with incombustible silicon fittings
 - Suitable for boiler steam ironing
- Electric cable and plug certified by CE
 - Special cable holder design to facilitate ironing
- Plastic foot caps that prevent slipping
 - Warranty 2 years

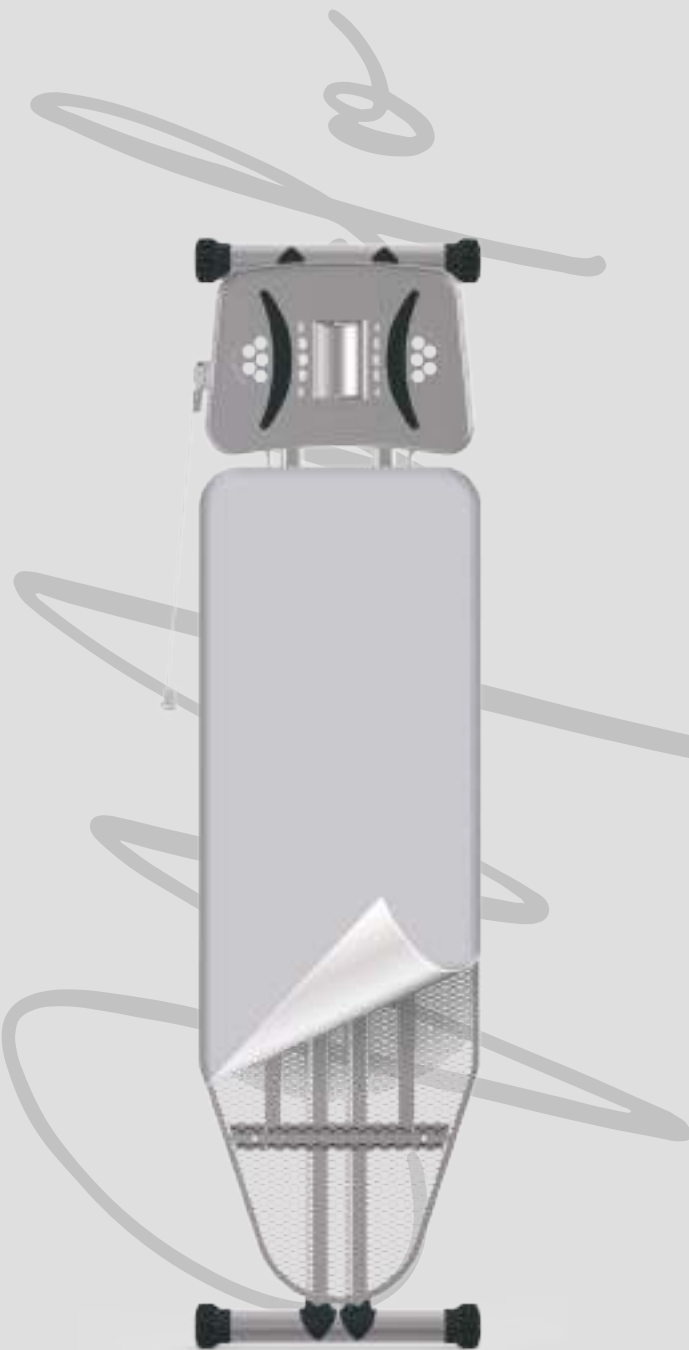
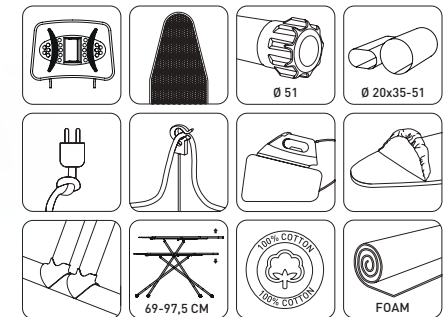

MONDO										
18326	156x97,5x43	42x125	43x168	8,1	0,0567375	20x35-51	2	15x170x44,5	0,113475	16,5

JUMBO

18324

- Automatic height adjustment from 67,5 to 94,5 cm
 - Completely electrostatic stainless paint
- 43x125 cm monoblock top ironing surface
 - Colored, bright, cotton cover
 - Using high quality foam under fabric
 - Special iron rest with non-flammable silicon iron support bar
 - Suitable for boiler steam ironing
- Electric cable and plug certified by CE
 - Plastic foot caps that prevent slipping
 - Warranty 2 years

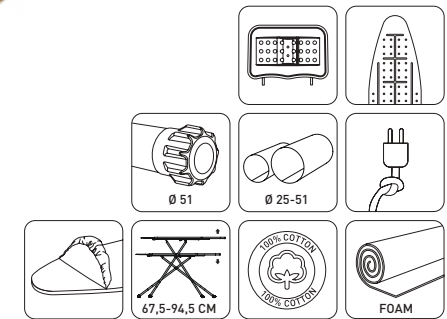

JUMBO											
18324	154x94,5x43	43x125	43x161	6,76	0,06314	25-51	2	17,5x174x44	0,12628	16,8	

VIVA

18323

- Automatic height adjustment from 69 to 97,5 cm
 - Completely electrostatic stainless paint
- 43x125 cm monoblock top ironing surface
 - Colored, bright, cotton and polyester cover
 - Using high quality foam under fabric
 - Special iron rest with incombustible silicon fittings
- Suitable for boiler steam ironing
- Electric cable and plug certified by CE
 - Special cable holder design to facilitate ironing
- Special iron rest design for hanging ironed clothes
 - Plastic foot caps that prevent slipping
 - Warranty 2 years

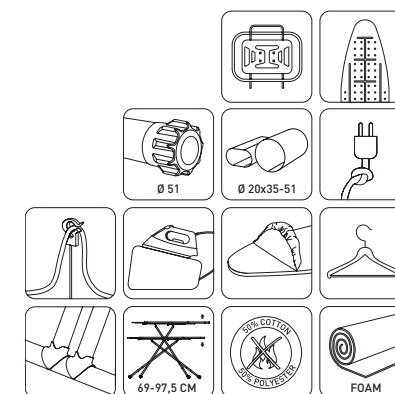

TS EN ISO 9001:2015
01 100 901545



20

VIVA



160x97,5x43

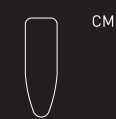

43x125



43x169



7,9



0,064702

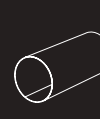

20x35-51



2



17x173x44



0,129404



17,5

PRESTIGE

18320

- Automatic height adjustment from 82 to 96 cm
- Completely electrostatic stainless paint
 - 42x125 cm mesh top ironing surface
 - Colored, bright, cotton cover
 - Using high quality foam under fabric
 - Special iron rest with incombustible silicon fittings
 - Suitable for boiler steam ironing
- Electric cable and plug certified by CE
 - Special cable holder design to facilitate ironing
 - Special iron rest design for hanging ironed clothes
- Plastic foot caps that prevent slipping
 - Warranty 2 years

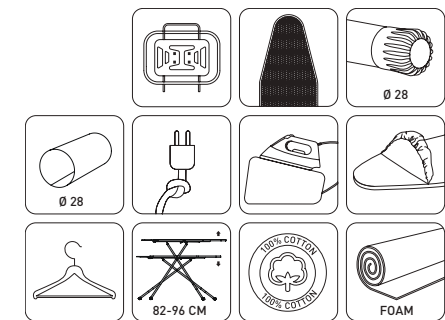

PRESTIGE										
18320	157x96x42,5	42x125	42,5x175	6,5	0,0542997	28	2	14x175,5x44,2	0,1085994	15,95

CARINO LUX

18302

- Automatic height adjustment from 62 to 92 cm
- Completely electrostatic stainless paint
 - 38x118 cm mesh top ironing surface
 - Colored, bright, cotton cover
 - Using high quality foam under fabric
 - Special iron rest with non-flammable silicon iron support bar
- Electric cable and plug certified by CE
 - Special linen rack
- Plastic foot caps that prevent slipping
 - Warranty 2 years

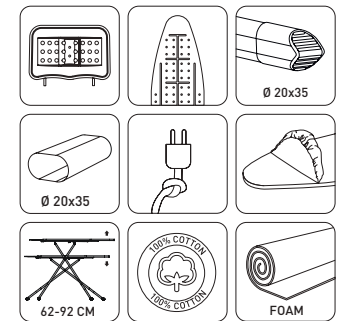

141x92x39

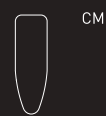

38x118



39x159

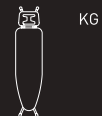

7,4

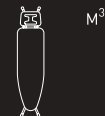

0,0501225

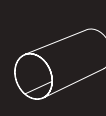

20x35



2



15x163x41



0,100245



15,5

SILVER

18348

- Automatic height adjustment from 63 to 92 cm
- Completely electrostatic stainless paint
 - 38x120 cm mesh top ironing surface
 - Colored, bright, cotton cover
 - Using high quality foam under fabric
- Special iron rest with incombustible silicon fittings
 - Suitable for boiler steam ironing
- Electric cable and plug certified by CE
 - Special cable holder design to facilitate ironing
 - Special iron rest design for hanging ironed clothes
- Plastic foot caps that prevent slipping
 - Warranty 2 years

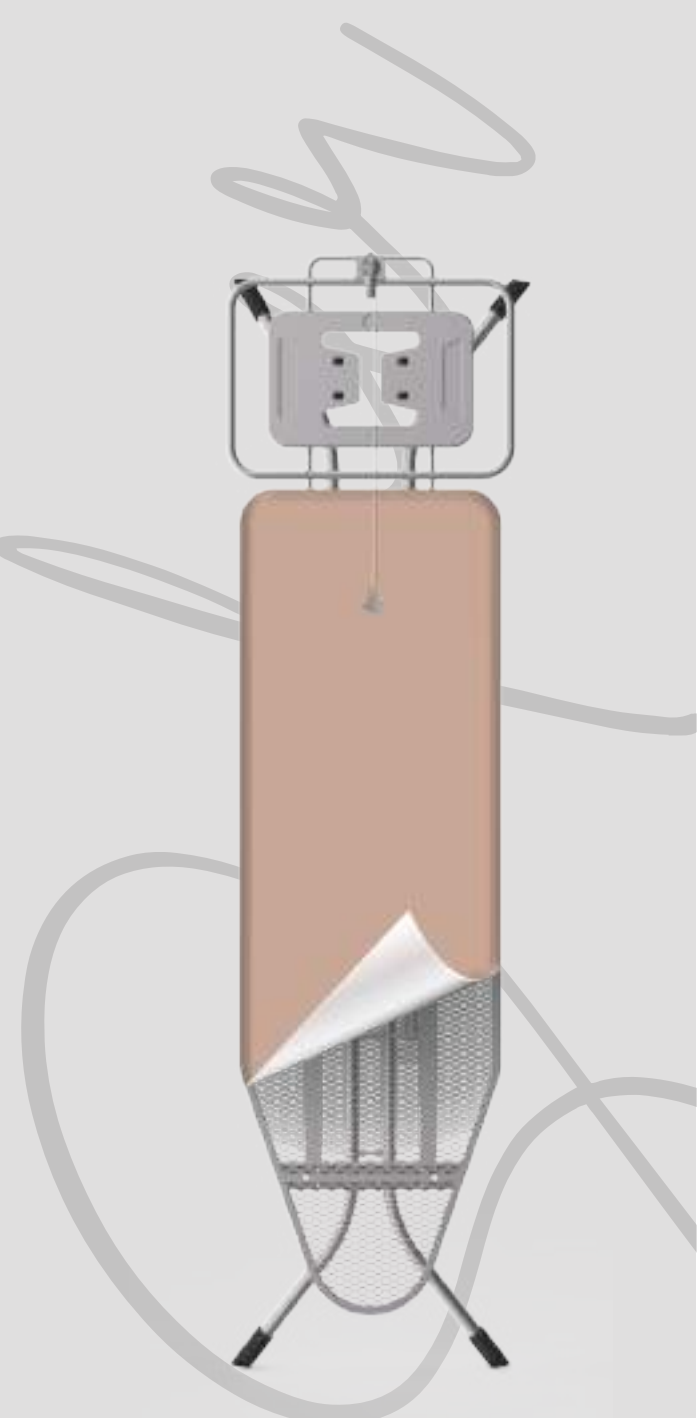
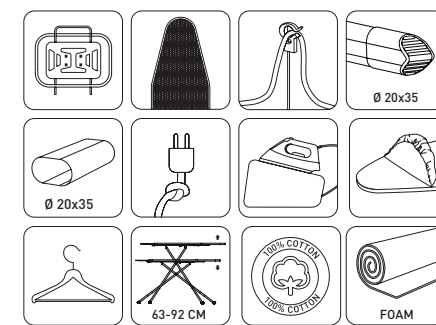

SILVER										
18348	154x92x39	38x120	39x168	6,45	0,0507	20x35	2	15x169x40	0,1014	13,4

FOCUS

18315

- Automatic height adjustment from 66 to 93 cm
 - Completely electrostatic stainless paint
- 38x118 cm monoblock top ironing surface
 - Colored, bright, cotton cover
 - Using high quality foam under fabric
 - Special iron rest with non-flammable silicon iron support bar
- Electric cable and plug certified by CE
 - Plastic foot caps that prevent slipping
 - Warranty 2 years

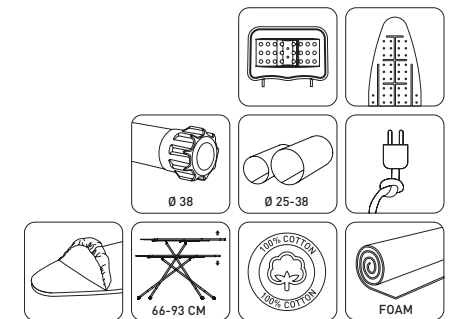

FOCUS										
18315	141x93x40,5	38x118	40,5x159	6,41	0,04856775	25x38	2	14,5x159,5x42	0,0971355	13,15

DREAM

18318

- Automatic height adjustment from 66 to 93 cm
 - Completely electrostatic stainless paint
- 40x118 cm monoblock top ironing surface
 - Colored, bright, cotton cover
 - Using high quality foam under fabric
 - Special iron rest with incombustible silicon fittings
- Electric cable and plug certified by CE
- Plastic foot caps that prevent slipping
 - Warranty 2 years

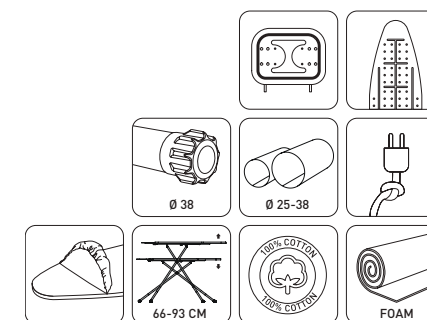

DREAM										
18318	141x93x40,5	40x118	40,5x159	5,44	0,4856775	25x38	2	14,5x159,5x42	0,0971355	12,5

MAGIC

18325

- Automatic height adjustment from 66 to 93 cm
 - Completely electrostatic stainless paint
- 38x118 cm monoblock top ironing surface
 - Colored, bright, cotton cover
 - Using high quality foam under fabric
 - Special iron rest with incombustible silicon fittings
- Electric cable and plug certified by CE
- Plastic foot caps that prevent slipping
 - Warranty 2 years

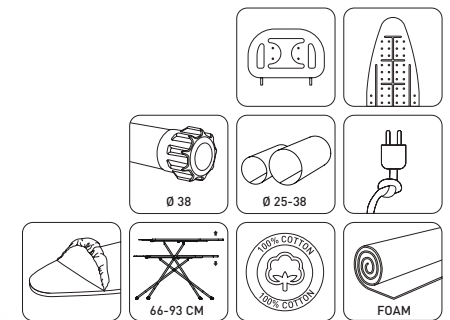

26

MAGIC

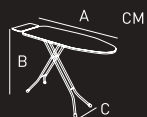

143x93x40,5

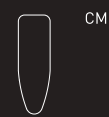

38x118



40,5x159

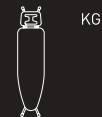

5,9



0,04856775

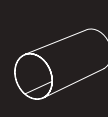

25x38



2



14,5x159,5x42



0,0971355



12,6

CAPITOL

18304

- Automatic height adjustment from 70 to 96 cm
 - Completely electrostatic stainless paint
 - 38x120 cm mesh top ironing surface
- Colored, bright, cotton and polyester cover
 - Using high quality foam under fabric
 - Special iron rest with incombustible silicon fittings
- Suitable for boiler steam ironing
- Electric cable and plug certified by CE
 - Special cable holder design to facilitate ironing
- Special iron rest design for hanging ironed clothes
- Plastic foot caps that prevent slipping
 - Warranty 2 years

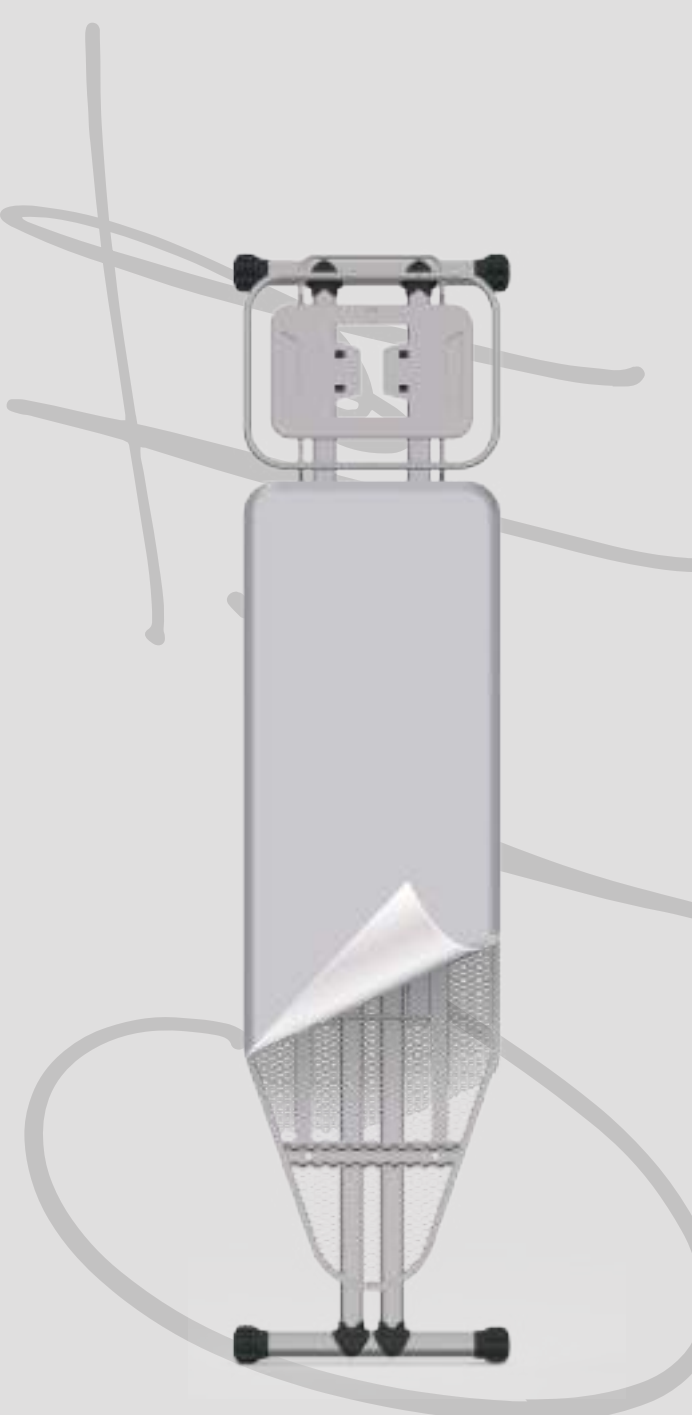
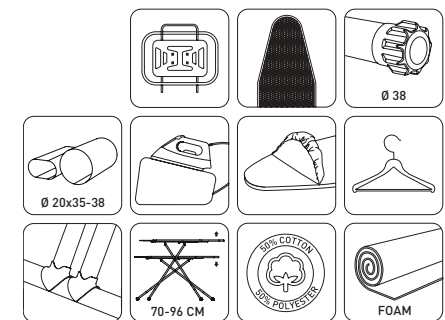

CAPITOL										
18304	154x96x40,5	38x120	40,5x166,5	6,05	0,048951	20x35-38	2	14x166,5x42	0,097902	13,75

CARINO

18301

- Automatic height adjustment from 66 to 92 cm
 - Completely electrostatic stainless paint
- 38x118 cm monoblock top ironing surface
 - Colored, bright, cotton cover
 - Using high quality foam under fabric
 - Special iron rest with non-flammable silicon iron support bar
- Electric cable and plug certified by CE
- Plastic foot caps that prevent slipping
 - Warranty 2 years

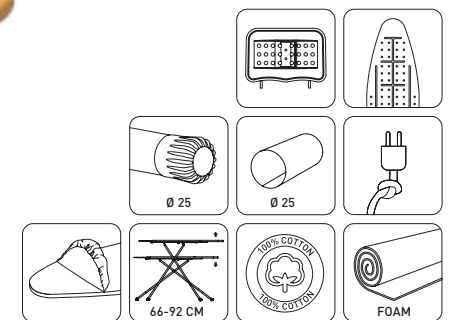

28

CARINO



141x92x38



38x118



38x158



5,95

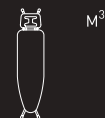

0,047251875

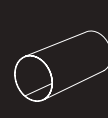

25



2



15x159,5x39,5



0,09450375



13,7

ATOS

18340

- Automatic height adjustment from 66 to 93 cm
 - Completely electrostatic stainless paint
- 36x112 cm monoblock top ironing surface
 - Colored, bright, cotton and polyester cover
 - Using high quality foam under fabric
 - Special iron rest with incombustible silicon fittings
- Electric cable and plug certified by CE
 - Plastic foot caps that prevent slipping
 - Warranty 2 years

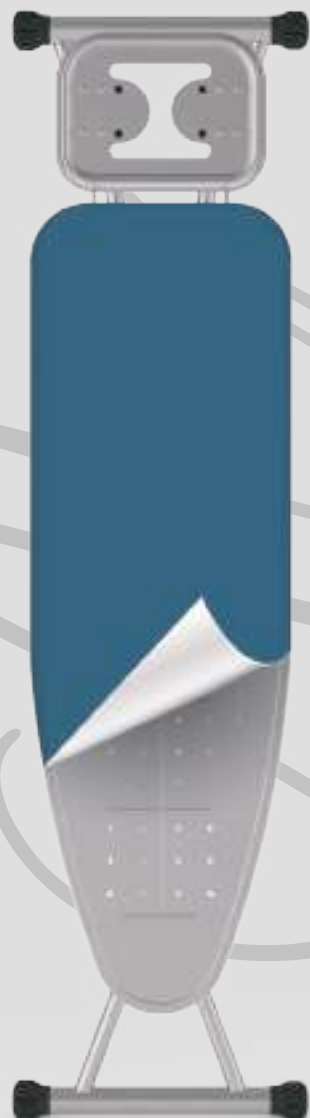
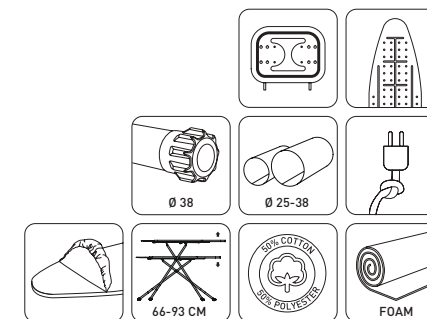

ATOS										
18340	135x93x40,5	36x112	40,5x159	5,6	0,04856775	25-38	2	14,5x159,5x42	0,0971355	13,5

SAMBA LUX

18336

- Automatic height adjustment from 62 to 90 cm
 - Completely electrostatic stainless paint
- 36x112 cm monoblock top ironing surface
 - Colored, bright, cotton cover
 - Using high quality foam under fabric
 - Special iron rest with incombustible silicon fittings
- Electric cable and plug certified by CE
- Plastic foot caps that prevent slipping
 - Warranty 2 years

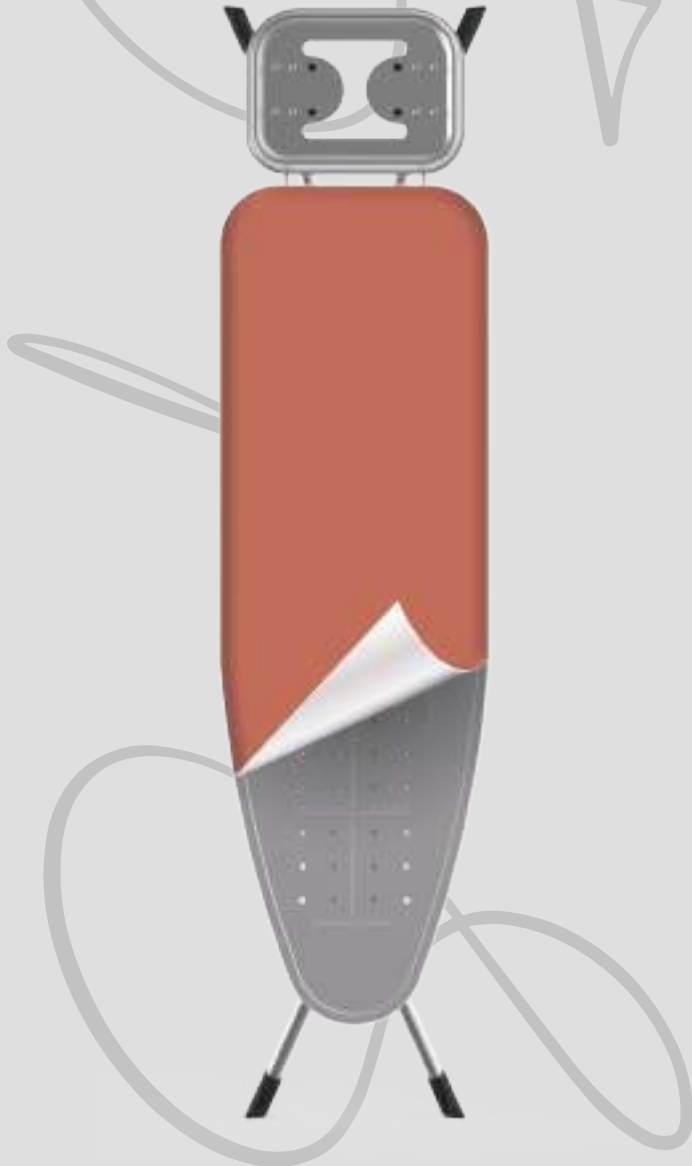
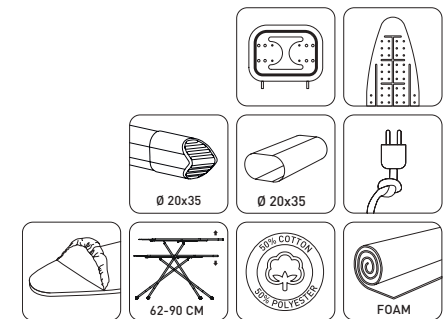

30

SAMBA LUX



135x90x36

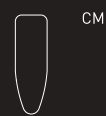

36x112



36x150



5,4

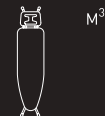

0,03598125

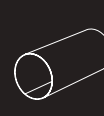

20x35



2

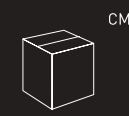

12,5x151,5x38



0,0719625



11,65

ARES

18367

- Automatic height adjustment from 66 to 93 cm
 - Completely electrostatic stainless paint
- 36x112 cm monoblock top ironing surface
 - Colored, bright, cotton and polyester cover
 - Using high quality foam under fabric
 - Special iron rest with incombustible silicon fittings
- Plastic foot caps that prevent slipping
 - Warranty 2 years

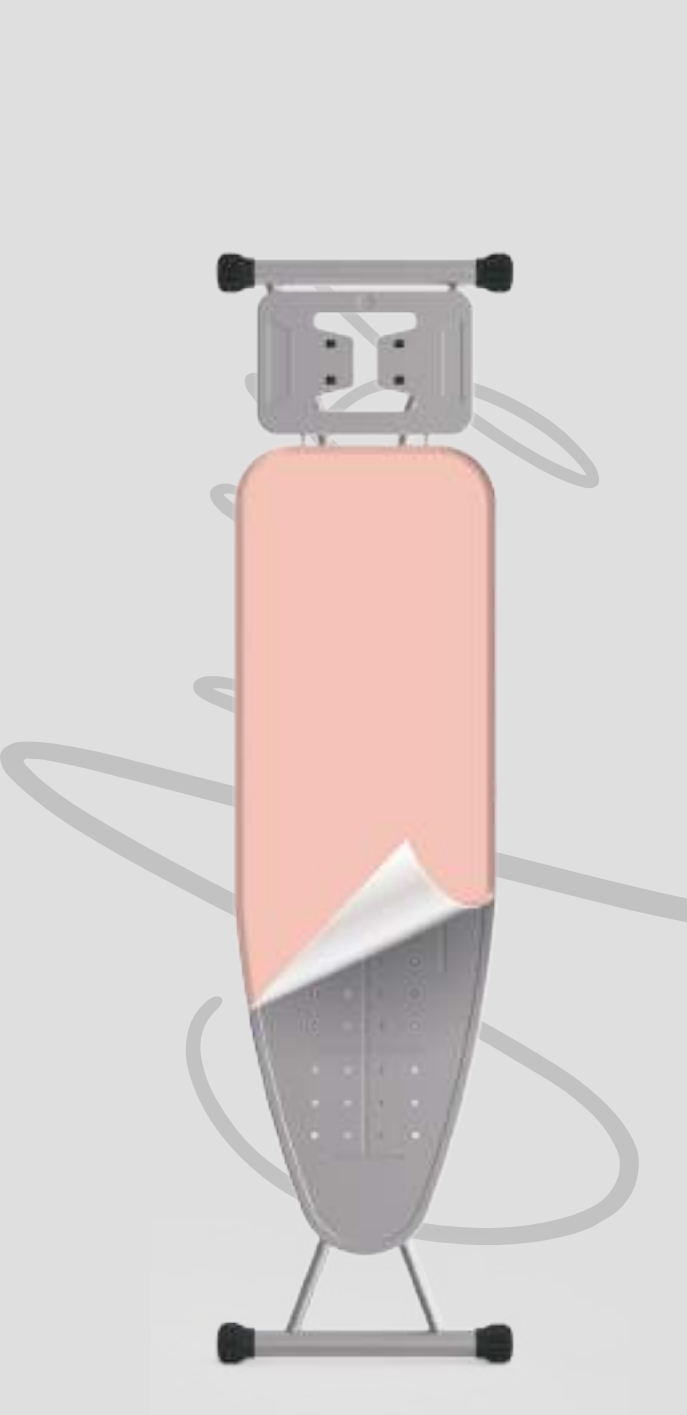
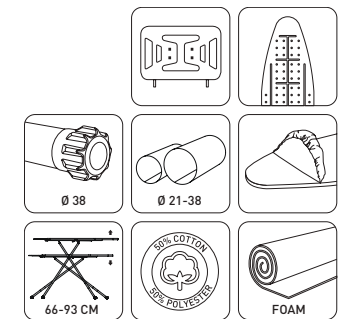

ARES										
18367	133x93x40,5	36x112	40,5x156	4,95	0,04177125	21-38	4	23,5x158x45	0,167085	18,7

ADA

18369

- Automatic height adjustment from 66 to 93 cm
 - Completely electrostatic stainless paint
 - 38x120 cm monoblock top ironing surface
 - Colored, bright, cotton and polyester cover
 - Using high quality foam under fabric
 - Special iron rest with incombustible silicon fittings
- Plastic foot caps that prevent slipping
 - Warranty 2 years

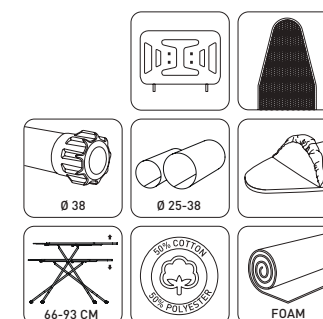

ADA										
18369	141x93x40,5	38x120	40,5x159	5,15	0,04856775	25-38	2	14,5x159,5x42	0,0971355	10,6

DINAMIC

18355

- Automatic height adjustment from 66,5 to 92 cm
 - Completely electrostatic stainless paint
- 33x110 cm monoblock top ironing surface
 - Colored, bright, cotton cover
 - Using high quality foam under fabric
 - Special iron rest with non-flammable silicon iron support bar
- Plastic foot caps that prevent slipping
 - Warranty 2 years

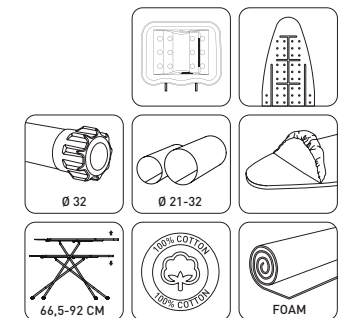

DINAMIC	A CM B C	CM	CM	KG	M ³	Ø	PCS	CM	M ³	KG
18355	132x92x33	33x110	33x155	4,8	0,02925	21-32	4	20x156x37,5	0,117	20

SERA

18368

- Automatic height adjustment from 66 to 93 cm
 - Completely electrostatic stainless paint
 - 34x114 mesh top ironing surface
- Colored, bright, cotton and polyester cover
 - Using high quality foam under fabric
 - Special iron rest with incombustible silicon fittings
- Plastic foot caps that prevent slipping
 - Warranty 2 years

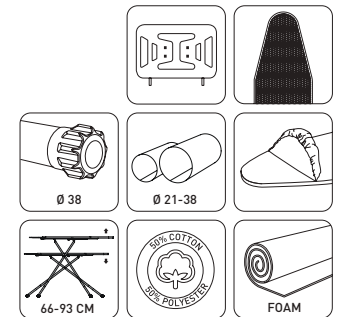

SERA	A CM B C	CM	CM	KG	M ³	Ø	PCS	CM	M ³	KG
18368	135x93x40,5	34x114	40,5x156	4,4	0,04177125	21-38	4	23,5x158x45	0,167085	18,4

BONUS

18346

- Automatic height adjustment from 65 to 90 cm
- Completely electrostatic stainless paint
 - 38x110 cm mesh top ironing surface
 - Colored, bright, cotton cover
 - Using high quality foam under fabric
 - Special iron rest with incombustible silicon fittings
- Electric cable and plug certified by CE
- Plastic foot caps that prevent slipping
 - Warranty 2 years

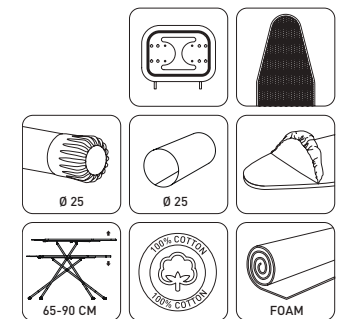

BONUS											
18346	133x90x36,5	38x110	36,5x150	4,1	0,02736	25	4	18x152x40	0,10944	17,6	

IDEAL

18356

- Automatic height adjustment from 66 to 88 cm
 - Completely electrostatic stainless paint
- 33x110 cm monoblock top ironing surface
 - Colored, bright, cotton cover
 - Using high quality foam under fabric
 - Special iron rest with incombustible silicon fittings
- Plastic foot caps that prevent slipping
 - Warranty 2 years

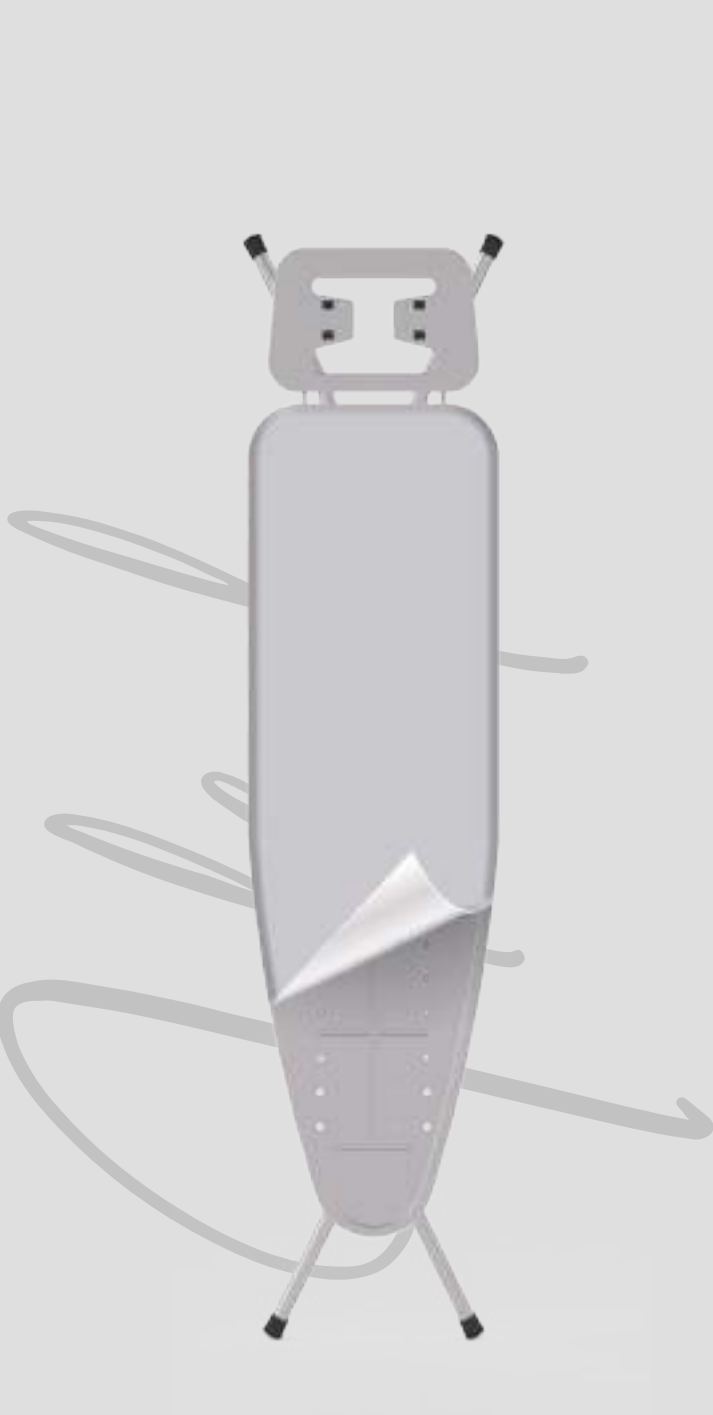
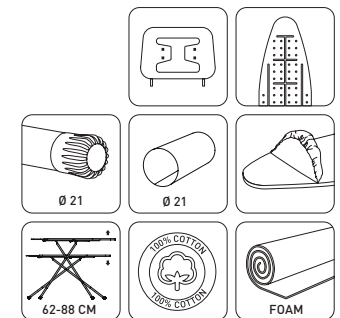

36

IDEAL										
18356	130,5x88x34,5	33x110	34,5x146,5	4,05	0,025137	21	4	19x147x36	0,100548	18,65

AQUA LUX

18365

- Automatic height adjustment from 63 to 92 cm
 - Completely electrostatic stainless paint
 - 38x120 cm mesh top ironing surface
- Colored, bright, cotton and polyester cover
 - Using high quality foam under fabric
 - Special iron rest with incombustible silicon fittings
- Plastic foot caps that prevent slipping
 - Warranty 2 years

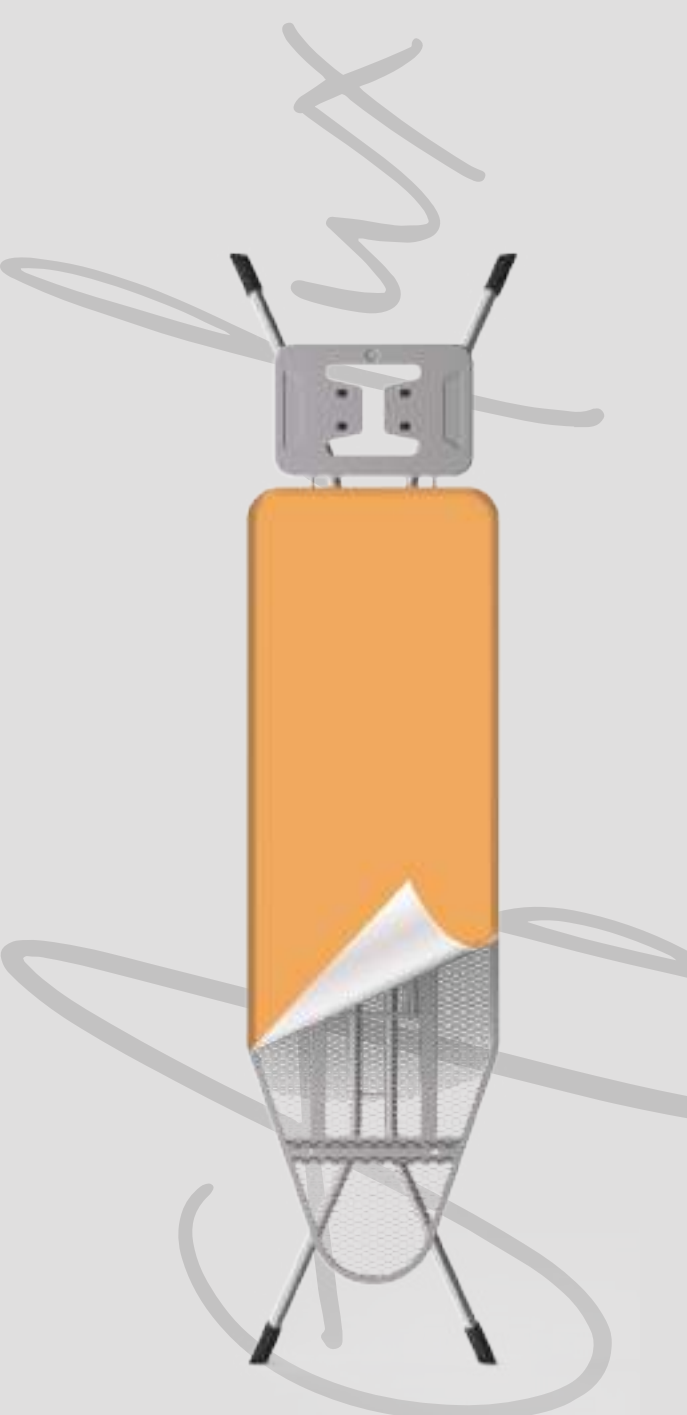
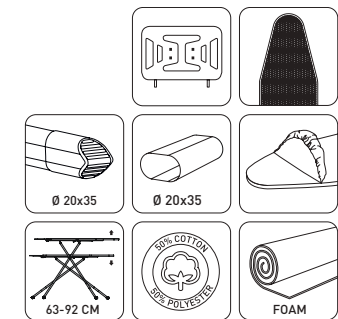

AQUA LUX										
18365	141X92X39	38X120	39X159,5	5,05	0,043335	20X35	2	13,5X160,5X40	0,08667	11,5

AQUA 25

18349

- Automatic height adjustment from 66 to 92 cm
- Completely electrostatic stainless paint
- 38x120 cm mesh top ironing surface
- Colored, bright, cotton and polyester cover
 - Using high quality foam under fabric
 - Special iron rest with incombustible silicon fittings
- Plastic foot caps that prevent slipping
 - Warranty 2 years

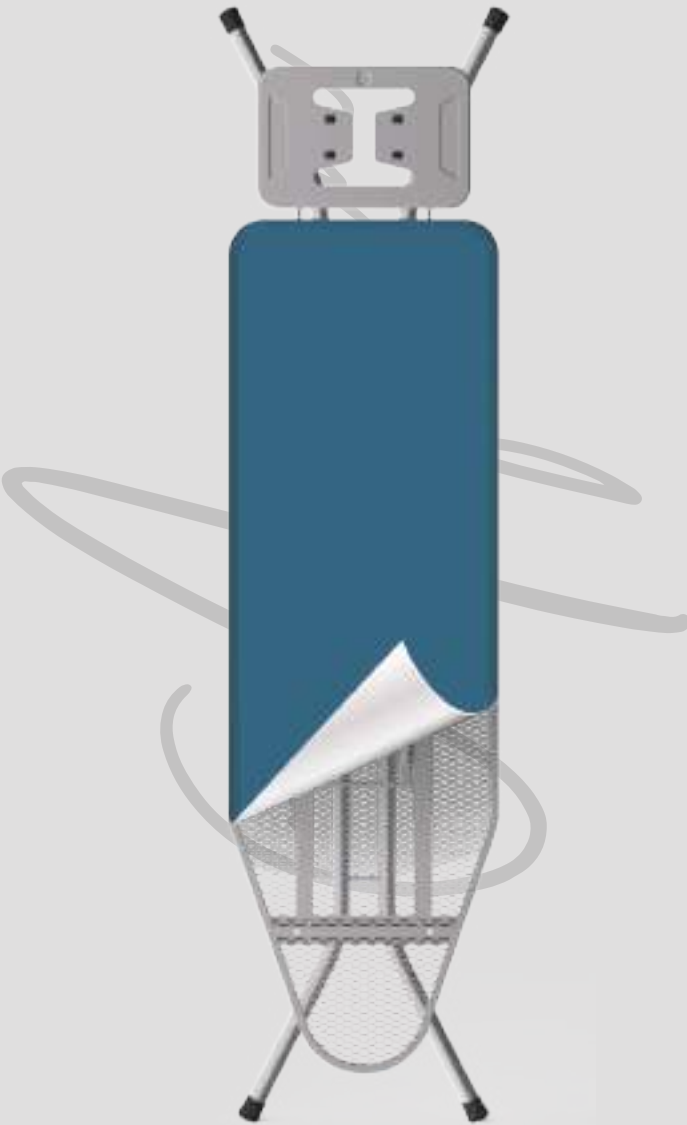
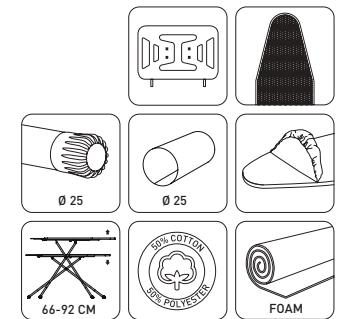

AQUA 25										
18349	141X92X38	38x120	38X158	4,6	0,036455	25	2	11,5X158,5X40	0,07291	9,95

AQUA 21

18364

- Automatic height adjustment from 66 to 92 cm
 - Completely electrostatic stainless paint
 - 38x120 cm mesh top ironing surface
- Colored, bright, cotton and polyester cover
 - Using high quality foam under fabric
 - Special iron rest with incombustible silicon fittings
- Plastic foot caps that prevent slipping
 - Warranty 2 years

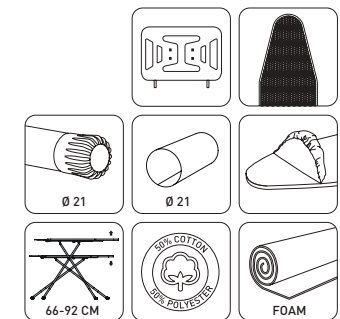

AQUA 21										
18364	141x92x38	38x120	38x158	4,675	0,036455	21	2	11,5x158,5x40	0,07291	9,35

DIAMOND

18366

- Automatic height adjustment from 65,5 to 92 cm
 - Completely electrostatic stainless paint
 - 33x110 cm monoblock top ironing surface
 - Colored, bright, cotton and polyester cover
 - Using high quality foam under fabric
 - Special iron rest with incombustible silicon fittings
- Plastic foot caps that prevent slipping
 - Warranty 2 years

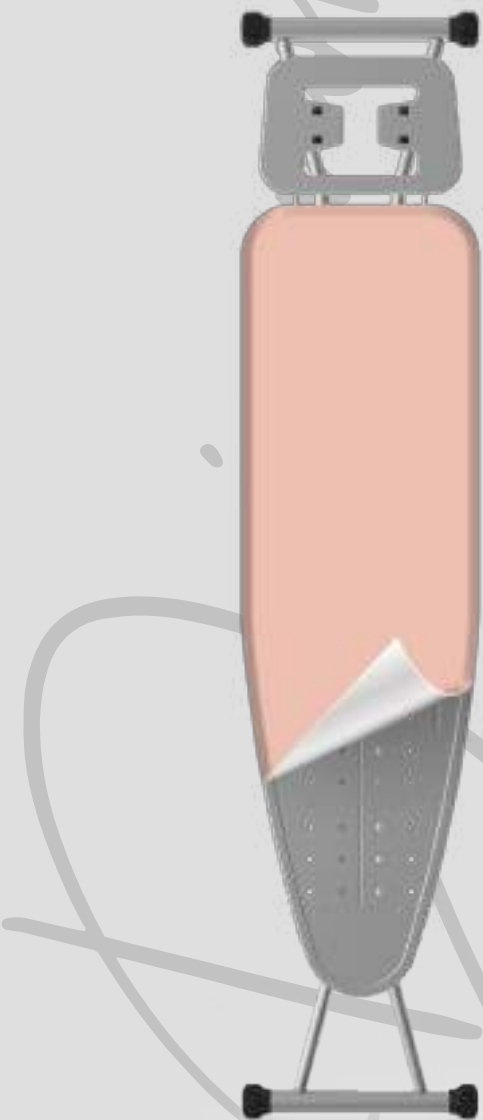
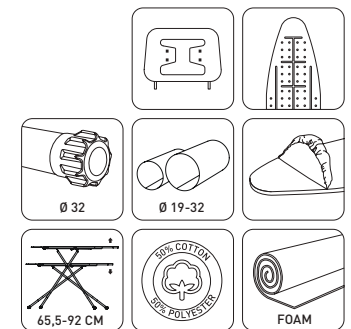

40

DIAMOND



130,5X92X33



33x110



33X154



4,1



0,02925

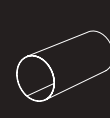

19-32



4



20X156X37,5



0,117



16,8

POWER

18347

- Automatic height adjustment from 62 to 88 cm
 - Completely electrostatic stainless paint
 - 38x110 cm mesh top ironing surface
- Colored, bright, cotton and polyester cover
 - Using high quality foam under fabric
 - Special iron rest with incombustible silicon fittings
- Plastic foot caps that prevent slipping
 - Warranty 2 years

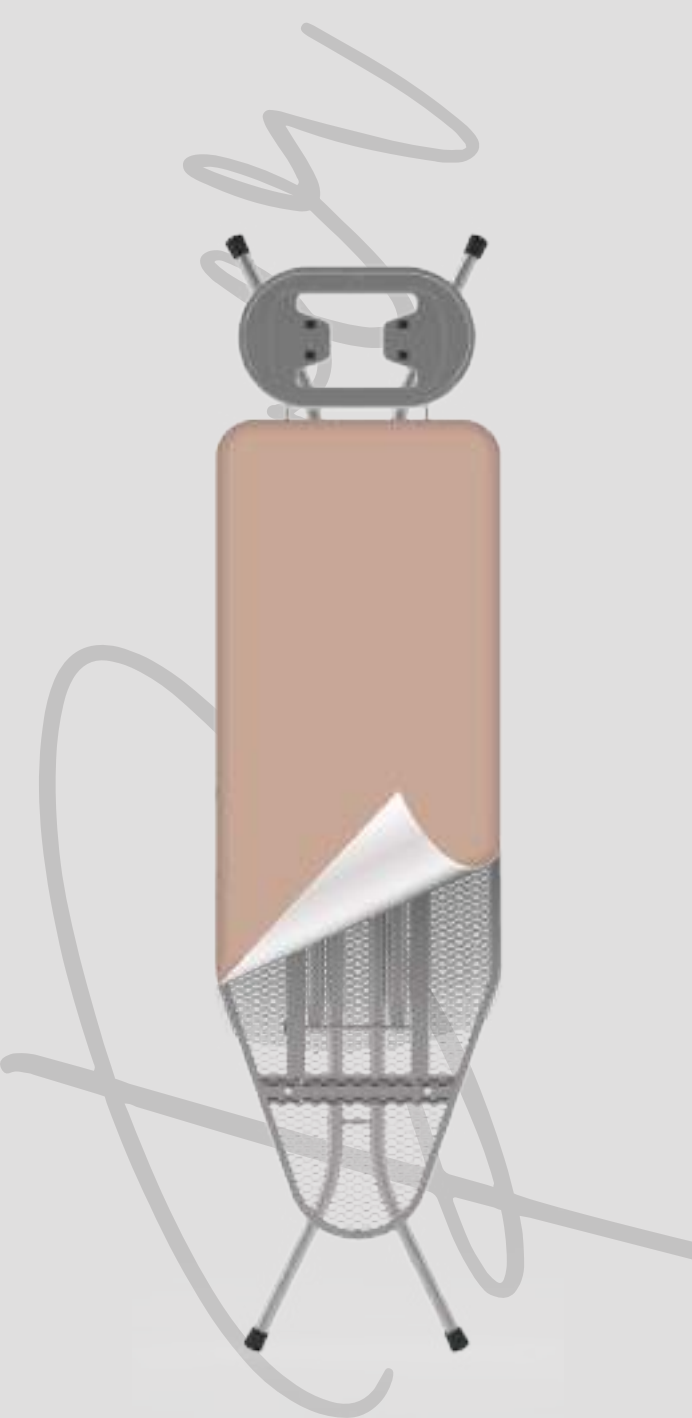
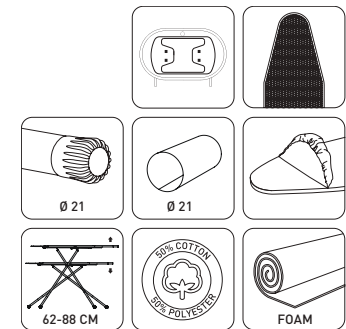

POWER										
18347	130X88X34,5	38x110	34,5X146,5	4,1	0,02499	21	4	17X147X40	0,09996	16,7

BASIC

18343

- Automatic height adjustment from 66,5 to 92 cm
- Completely electrostatic stainless paint
 - 33x110 cm mesh top ironing surface
 - Colored, bright, cotton cover
 - Using high quality foam under fabric
 - Special iron rest with incombustible silicon fittings
- Plastic foot caps that prevent slipping
 - Warranty 2 years

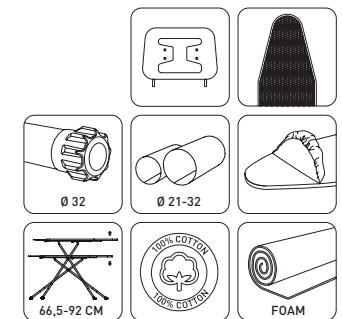

42

BASIC



130X92X33



33X110



33X155



3,95



0,02925

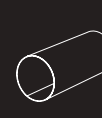

21-32



4



20X156X37,5



0,117



17

BRAVA

18344

- Automatic height adjustment from 62 to 88 cm
 - Completely electrostatic stainless paint
 - 33x110 cm mesh top ironing surface
- Colored, bright, cotton and polyester cover
 - Using high quality foam under fabric
 - Special iron rest with incombustible silicon fittings
- Plastic foot caps that prevent slipping
 - Warranty 2 years

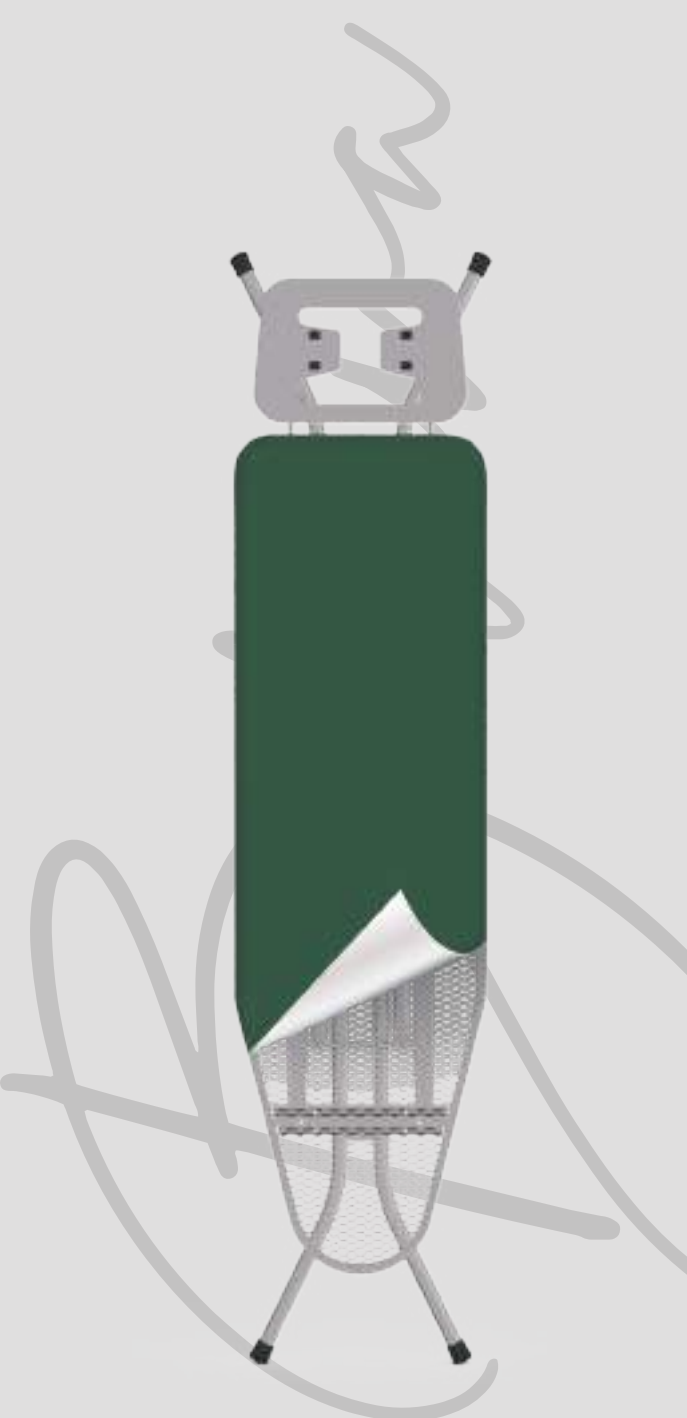
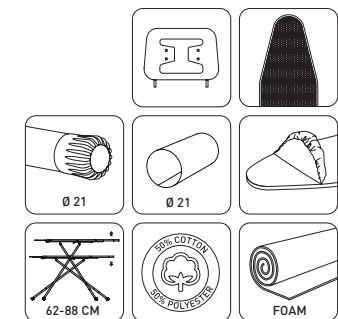

BRAVA										
18344	130X88X34,5	33x110	34,5X146,5	3,85	0,022178625	21	4	17X147X35,5	0,0887145	15

ONE

18358

- Automatic height adjustment from 62-87 cm
- Completely electrostatic stainless paint
 - 30x105 cm mesh top ironing surface
 - Colored, bright, cotton cover
 - Using high quality foam under fabric
 - Special iron rest with incombustible silicon fittings
- Plastic foot caps that prevent slipping
 - Warranty 2 years

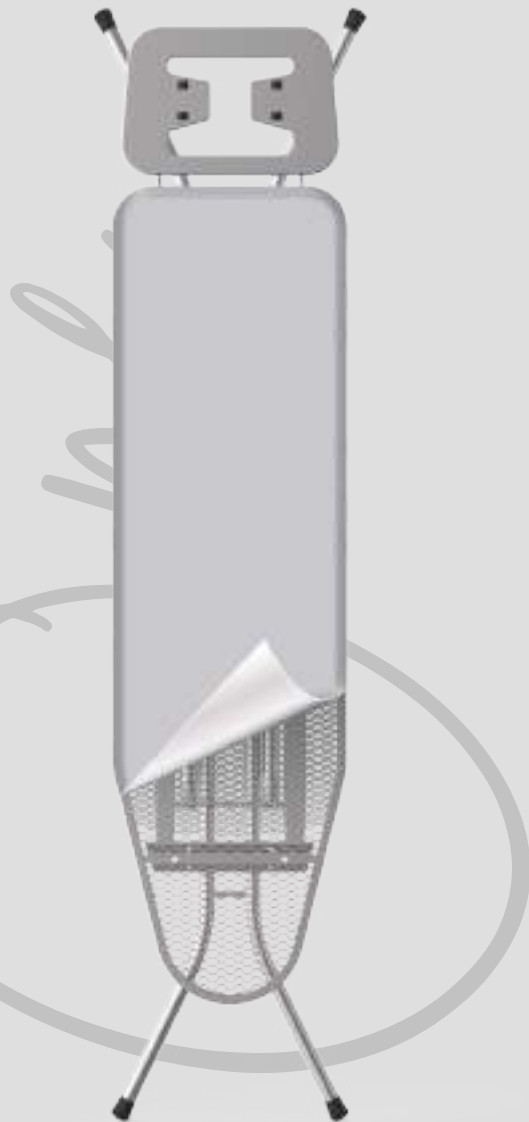
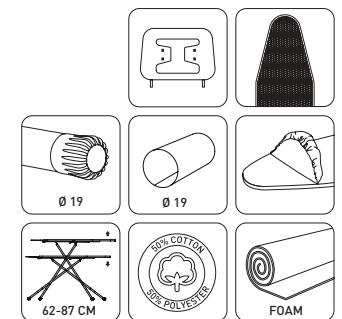

44

ONE	A CM B C	CM	CM	KG	M ³	Ø	PCS	CM	M ³	KG
18358	125x87x33	30x105	33x144,5	3,05	0,020339083	19	6	24,5x146,5x34	0,1220345	13

MINI ONE

18359

- Automatic height adjustment from 63,5 to 81,5 cm
 - Completely electrostatic stainless paint
 - 30x90 cm mesh top ironing surface
- Colored, bright, cotton and polyester cover
 - Using high quality foam under fabric
 - Plastic foot caps that prevent slipping
 - Warranty 2 years

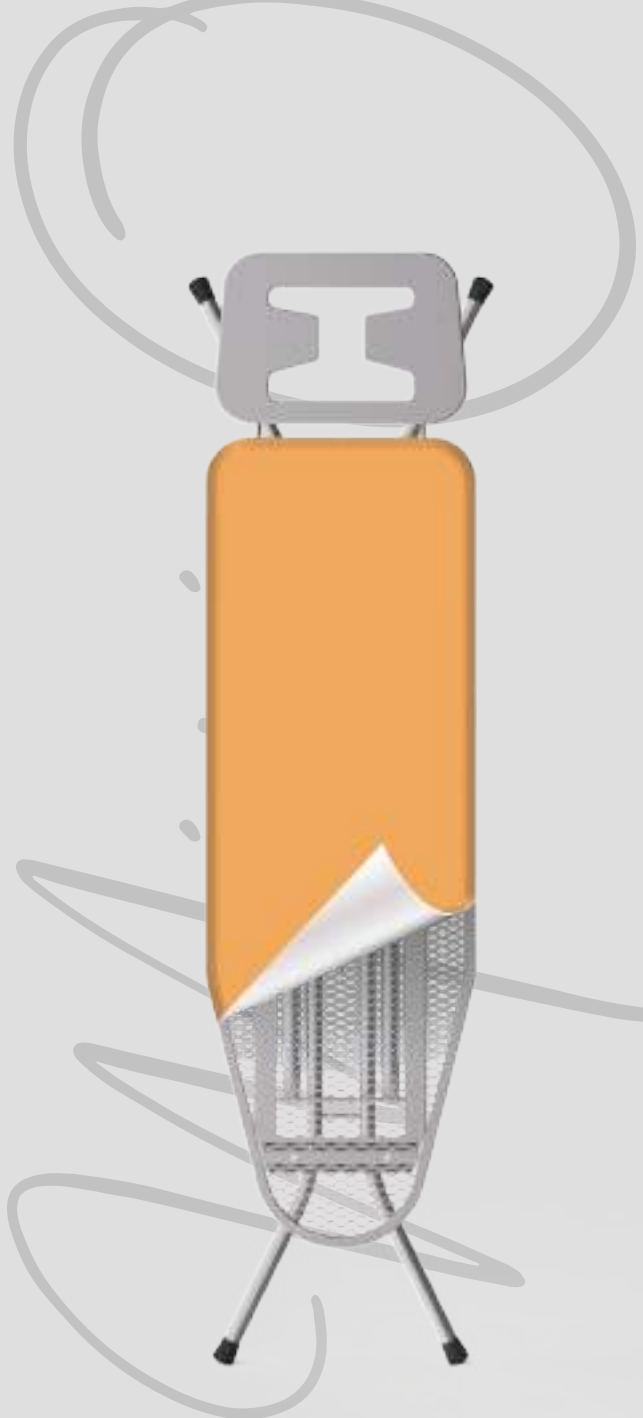
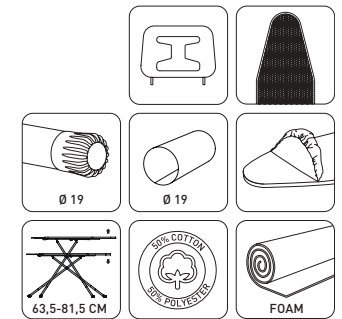

MINI ONE										
18359	110x81,5x30	30x90	30x120	2,6	0,01575	19	8	31,5x125x32	0,126	17,5

TABLE TOP

18360

- Completely electrostatic stainless paint
 - 30x74 cm mesh top ironing surface
 - Hook for hanging
- Colored, bright, cotton and polyester cover
 - Using high quality foam under fabric
- Plastic foot caps that prevent slipping
 - Special design to facilitate ironing
 - Warranty 2 years

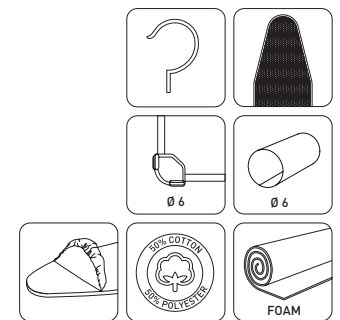

46

TABLE TOP



74,5x15x30



30x74



30x74,5



1

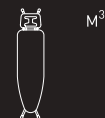

0,0061425

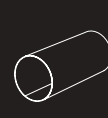

6



10



26x75x31,5



0,061425

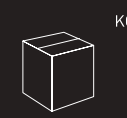

12,4

Tube DETAILS

A

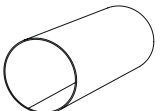

Ø 6
18360 TABLE TOP

B

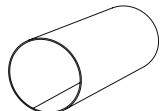

Ø 19
18358 ONE
18359 MINI ONE

C

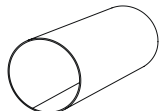

Ø 21
18344 BRAVA
18344-20 CITY SERIES
18347 POWER
18356 IDEAL
18364 AQUA 21
18364-20 STONE SERIES

D

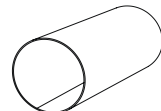

Ø 25
18301 CARINO
18346 BONUS
18349 AQUA 25

E



Ø 28
18320 PRESTIGE

F

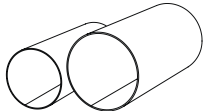

Ø 19-32
18366 DIAMOND

G

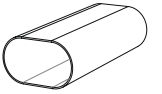

Ø 20x35
18302 CARINO LUX
18336 SAMBA LUX
18348 SILVER
18365 AQUA LUX

H

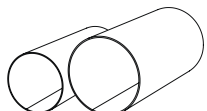

Ø 21-32
18343 BASIC
18355 DINAMIC

I

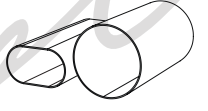

Ø 23x35-51
18323 VIVA
18326 MONDO
18326-20 DIAMOND SERIES
18327 MONO MONDO
18328 MERIVA

J

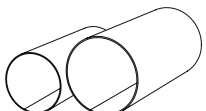

Ø 20x35-38
18304 CAPITOL

K



Ø 25-38
18315 FOCUS
18318 DREAM
18325 MAGIC
18340 ATOS
18369 ADA

M

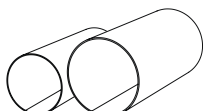

Ø 21-38
18367 ARES
18368 SERA

L



Ø 25-51
18324 JUMBO

Fabric DETAILS

CA-050	18318 DREAM
CA-061	
CA-064	18315 FOCUS
CA-065	
CA-082	18325 MAGIC
CA-083	
CA-084	18302 CARINO LUX
CA-085	
CA-086	18301 CARINO
CA-096	
CA-097	18346 BONUS
CA-118	
CA-186	18348 SILVER
CA-202	
CA-203	18336 SAMBA LUX
CA-204	
CA-204	18340 ATOS

CA-049	18343 BASIC
CA-202	
CA-203	
CA-204	18355 DINAMIC

CA-061	18327 MONO MONDO
CA-137	
CA-138	
CA-139	18328 MERIVA
CA-140	
CA-141	18323 VIVA
CA-152	
CA-153	18324 JUMBO
CA-154	
CA-155	
CA-202	18326 MONDO
CA-203	
CA-204	
CB-015	18320 PRESTIGE

	18304 CAPITOL
	18369 ADA
	18365 AQUA LUX
CB-212	18349 AQUA 25
CB-213	18364 AQUA 21
	18347 POWER
	18367 ARES

CB-019	18304 CAPITOL
CB-020	18369 ADA
CB-111	18365 AQUA LUX
CB-122	
CB-143	18349 AQUA 25
CB-144	18364 AQUA 21
CB-157	18347 POWER
CB-158	18367 ARES
CB-168	
CB-175	18368 SERA
CB-176	18344 BRAVA
CB-179	18356 IDEAL
CB-180	18366 DIAMOND
CB-183	18359 MINI ONE
CB-184	18360 TABLE TOP
CB-185	
CB-197	18358 ONE
CB-205	

	18368 SERA
	18344 BRAVA
CB-214	18356 IDEAL
CB-215	18366 DIAMOND
	18359 MINI ONE
	18360 TABLE TOP
	18358 ONE

FOUR DESIGNS MIXED



Table
DETAILS

A

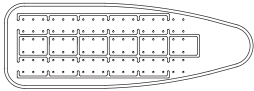

43x125 CM

18323 VIVA
18324 JUMBO
18327 MONO MONDO
18328 MERIVA

B

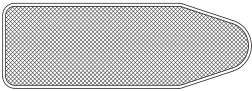

42x125 CM

18320 PRESTIGE
18326 MONDO
18326-20 DIAMOND SERIES

C

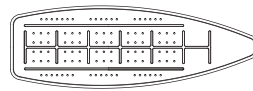

40x118 CM

18318 DREAM

D

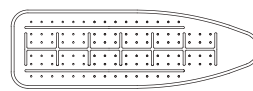

38x118 CM

18301 CARINO
18302 CARINO LUX
18315 FOCUS

E

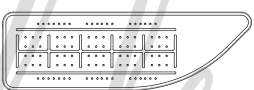

38x118 CM

18325 MAGIC

F

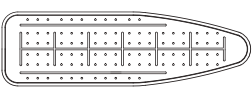

33x110 CM

18355 DINAMIC
18356 IDEAL
18366 DIAMOND

G

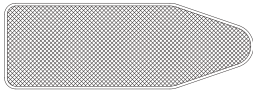

38x110 CM

18346 BONUS
18347 POWER

H

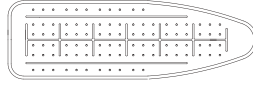

36x112 CM

18336 SAMBA LUX
18340 ATOS
18367 ARES

I

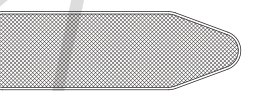

38x120 CM

18304 CAPITOL
18348 SILVER
18349 AQUA 25
18364 AQUA 21
18364-20 STONE SERIES
18365 AQUA LUX
18369 ADA

K

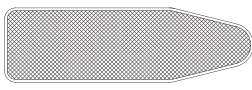

33x110 CM

18343 BASIC
18344 BRAVA
18344-20 CITY SERIES

L

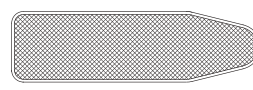

30x105 CM

18358 ONE

M



30x90 CM

18359 MINI ONE

N



30x74 CM

18360 TABLE TOP

O

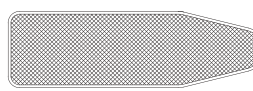

34x114 CM

18368 SERA



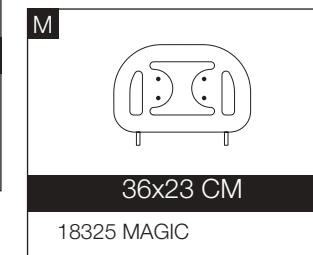
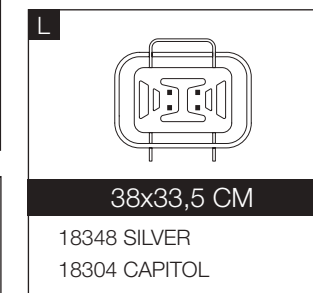
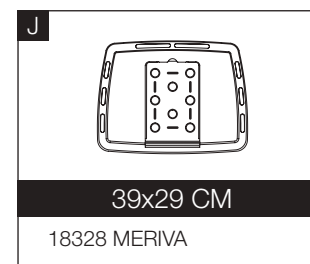
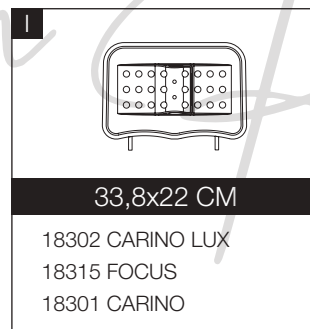
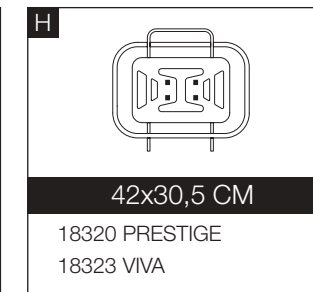
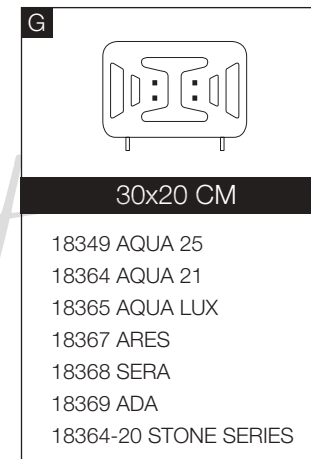
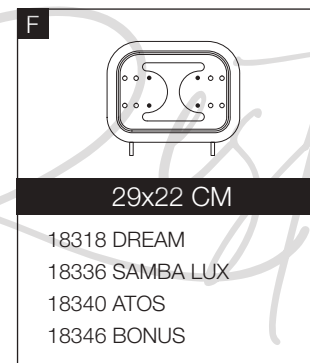
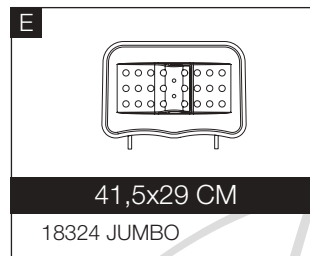
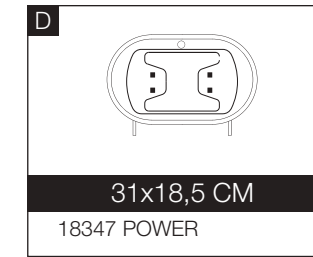
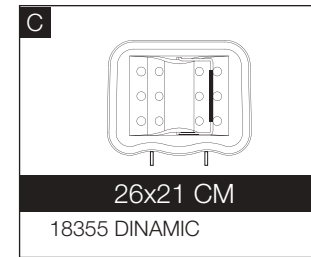
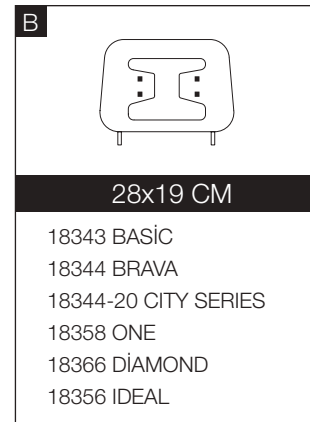
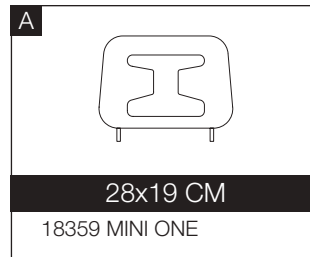



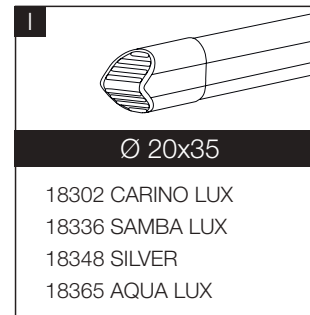
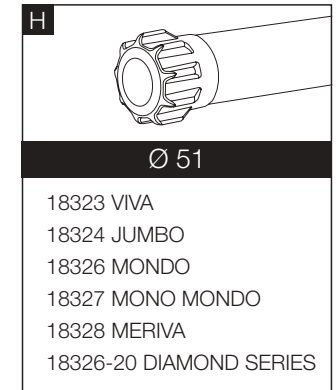
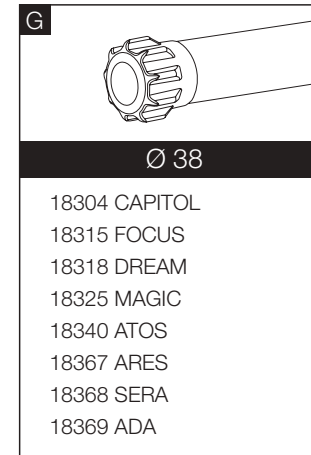
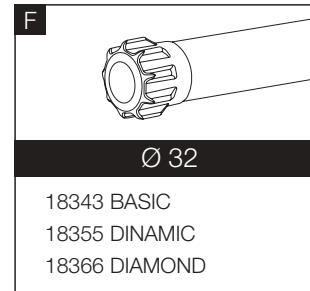
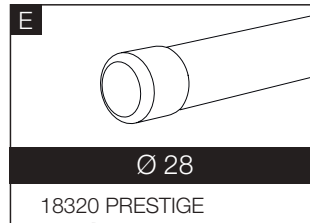
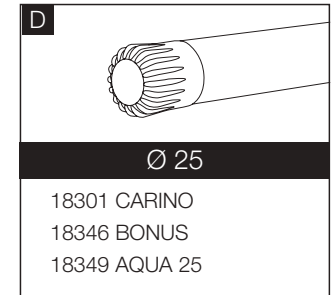
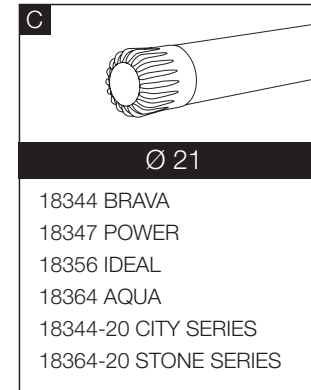
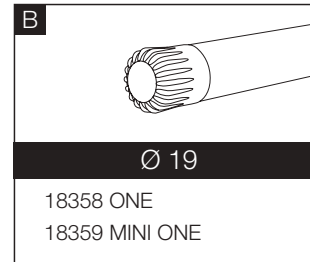
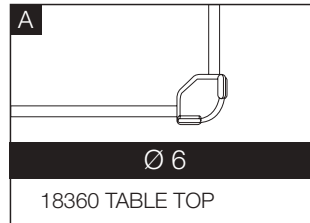

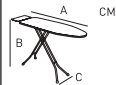

Iron Rest DETAILS



Cap DETAILS



Technical DETAILS

PRODUCT CODE	PRODUCT NAME	 CM	 CM	 CM	 KG	 M ³	 Ø	 PCS	 CM	 M ³	 KG
18326-20	DIAMOND SERIES	156x97,5x43	42x125	43x168	8,1	0,0567375	23x35-51	2	15x170x44,5	0,113475	16,5
18364-20	STONE SERIES	141x92x38	38x120	38x158	4,675	0,036455	21	2	11,5x158,5x40	0,07291	9,35
18344-20	CITY SERIES	130x88x34,5	33x110	34,5x146,5	3,85	0,022178625	21	4	17x147x35,5	0,0887145	15
18328	MERIVA	156x97,5x43	43x125	43x168	7,9	0,0777195	23x35-51	2	18x171x50,5	0,155439	17,5
18327	MONO MONDO	156x97,5x43	43x125	43x168	8,75	0,0567375	23x35-51	2	15x170x44,5	0,113475	18,3
18326	MONDO	156x97,5x43	42x125	43x168	8,1	0,0567375	23x35-51	2	15x170x44,5	0,113475	16,5
18324	JUMBO	154x94,5x43	43x125	43x161	6,76	0,06314	25-51	2	17,5x164x44	0,12628	16,8
18323	VIVA	160x97,5x43	43x125	43x169	7,9	0,064702	23x35-51	2	17x173x44	0,129404	17,5
18320	PRESTIGE	157x96x42,5	42x125	42,5x175	6,5	0,0542997	28	2	14x175,5x44,2	0,1085994	15,95
18318	DREAM	141x93x40,5	40x118	40,5x159	5,44	0,04856775	25-38	2	14,5x159,5x42	0,0971355	12,5
18369	ADA	141x93x40,5	38x120	40,5x159	5,15	0,04856775	25-38	2	14,5x159,5x42	0,0971355	10,6
18365	AQUA LUX	141x92x39	38x120	39x159,5	5,05	0,043335	20x35	2	13,5x160,5x40	0,08667	11,5
18364	AQUA 21	141x92x38	38x120	38x158	4,675	0,036455	21	2	11,5x158,5x40	0,07291	9,35
18349	AQUA 25	141x92x38	38x120	38x158	4,6	0,036455	25	2	11,5x158,5x40	0,07291	9,95
18348	SILVER	154x92x39	38x120	39x168	6,45	0,0507	20x35	2	15x169x40	0,1014	13,4
18304	CAPITOL	154x96x40,5	38x120	40,5x166,5	6,05	0,048951	25-51	2	14x166,5x42	0,097902	13,75
18325	MAGIC	143x93x40,5	38x118	40,5x159	5,9	0,04856775	25-38	2	14,5x159,5x42	0,0971355	12,6
18315	FOCUS	141x93x40,5	38x118	40,5x159	6,41	0,04856775	25-38	2	14,5x159,5x42	0,0971355	13,15
18302	CARINO LUX	141x92x39	38x118	39x159	7,4	0,0501225	20x35	2	15x163x41	0,100245	15,5
18301	CARINO	141x92x38	38x118	38x158	5,95	0,0439635	25	2	14x159x39,5	0,087927	13,7
18347	POWER	130x88x34,5	38x110	34,5x146,5	4,1	0,02499	21	4	17x147x40	0,09996	16,7
18346	BONUS	133x90x36,5	38x110	36,5x150	4,1	0,02736	25	4	18x152x40	0,10944	17,6
18367	ARES	133x93x40,5	36x112	40,5x156	4,95	0,04177125	21-38	4	23,5x158x45	0,167085	18,7
18340	ATOS	135x93x40,5	36x112	40,5x159	5,6	0,04856775	25-38	2	14,5x159,5x42	0,0971355	13,5
18336	SAMBA LUX	135x90x36	36x112	36x150	5,4	0,03598125	20x35	2	12,5x151,5x38	0,0719625	11,65
18368	SERA	135x93x40,5	34x114	40,5x156	4,4	0,04177125	21-38	4	23,5x158x45	0,167085	18,4
18366	DIAMOND	130,5x92x33	33x110	33x154	4,1	0,02925	19-32	4	20x156x37,5	0,117	16,8
18356	IDEAL	130,5x88x34,5	33x110	34,5x146,5	4,05	0,025137	21	4	19x147x36	0,100548	18,65
18355	DINAMIC	132x92x33	33x110	33x155	4,8	0,02925	21-32	4	20x156x37,5	0,117	20
18344	BRAVA	130x88x34,5	33x110	34,5x146,5	3,85	0,022178625	21	4	17x147x35,5	0,0887145	15
18343	BASIC	130x92x33	33x110	33x155	3,95	0,02925	21-32	4	20x156x37,5	0,117	17
18358	ONE	125x87x33	30x105	33x144,5	3,05	0,020638188	19	6	24,5x146,5x34,5	0,123829125	13
18359	MINI ONE	110x81,5x30	30x90	30x120	2,6	0,018259	19	6	28,5x124x31	0,109554	15,6
18360	TABLE TOP	74,5x15x30	30x74	30x74,5	1	0,0070875	6	10	30x75x31,5	0,070875	12,4

Clothes Dryer

Clothes Dryer

D

ryer



STREAM/4

18139

- Completely electrostatic stainless paint
 - Strong and durable metal skeleton
 - Foldable and easy to carry
 - For drying laundry in a small space
 - 4-storey hanging area suitable for different opening positions
 - Easy open-close feature with sliding joint mechanism
 - Hanger attachment for drying laundry with hanger
 - Thanks to its wheeled body, it can move anywhere
 - 40 m clothes line hanging capacity
 - 40 kg carrying capacity
 - Warranty 2 years

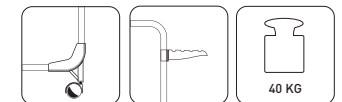
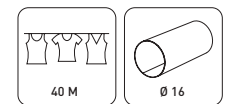

STREAM 4	CM	M	CM	KG	M ³	Ø	PCS	CM	M ³	KG
18139	70x70x163,5	163,5	70X163	4,75	0,04982445	16	4	17x167x70,2	0,1992978	19,4

STREAM/3

18138



- Completely electrostatic stainless paint
 - Strong and durable metal skeleton
 - Foldable and easy to carry
- For drying laundry in a small space
 - 3-storey hanging area suitable for different opening positions
- Easy open-close feature with sliding joint mechanism
 - Hanger attachment for drying laundry with hanger
 - Thanks to its wheeled body, it can move anywhere
- 30 m clothes line hanging capacity
 - 30 kg carrying capacity
 - Warranty 2 years

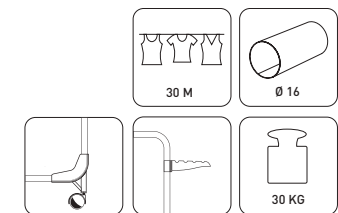

STREAM 3	CM	M	CM	KG	M ³	Ø	PCS	CM	M ³	KG
18138	70x70x134	30	130X71	3,85	0,0400248	16	4	17x130,8x72	0,16992	16,4

STREAM/2

18137

- Completely electrostatic stainless paint
 - Strong and durable metal skeleton
 - Foldable and easy to carry
 - For drying laundry in a small space
 - 2-storey hanging area suitable for different opening positions
 - Easy open-close feature with sliding joint mechanism
 - Hanger attachment for drying laundry with hanger
 - Thanks to its wheeled body, it can move anywhere
 - 20 m clothes line hanging capacity
 - 20 kg carrying capacity
 - Warranty 2 years

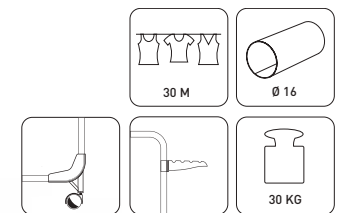

STREAM 2										
18137	89x68x68	20	67,5x90	2,90	0,0277	16	4	17x91x71,5	0,1106	15,55

ISTANBUL LUX 18142

- Completely electrostatic stainless paint
 - Foldable and easy to carry
 - Extra thick wire for high strength
 - Plastic apparatus for drying socks
 - Plastic caps that prevent slipping
- 18 m clothes line hanging capacity
 - 18 kg carrying capacity
 - Warranty 2 years

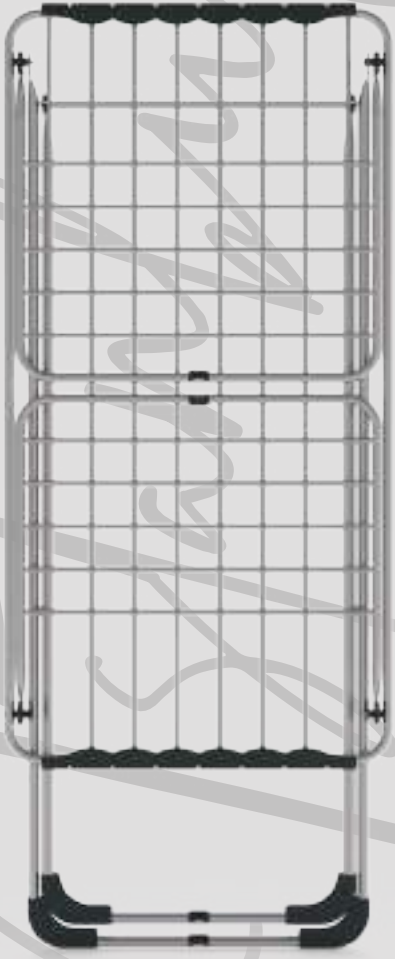
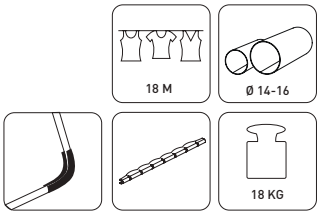

ISTANBUL LUX	CM	M	CM	KG	M ³	Ø	PCS	CM	M ³	KG
18142	177x51,5x107,5	18	54,5x132	3,20	0,025638667	14-16	6	20,5x134x56	0,153832	20

WINGS LUX

18111

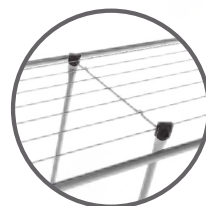
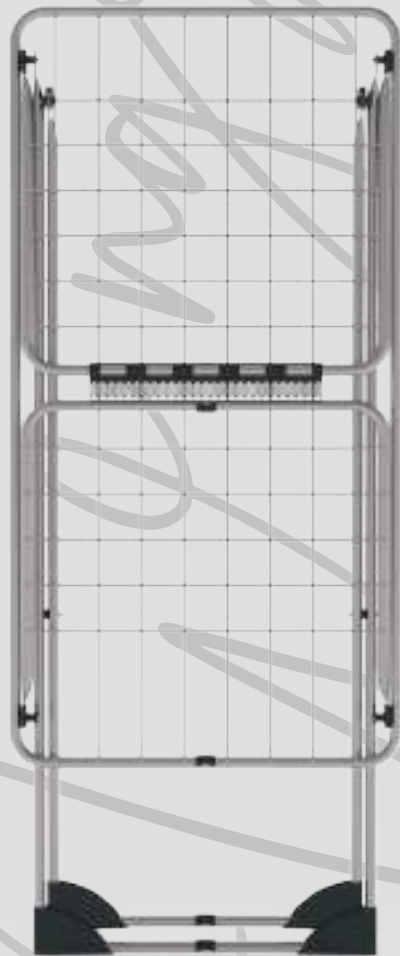

- Completely electrostatic stainless paint
 - Foldable and easy to carry
- Sliding mechanism that facilitates opening and closing
- Plastic apparatus for drying socks
- Plastic caps that prevent slipping
- 18 m clothes line hanging capacity
 - 18 kg carrying capacity
 - Warranty 2 years

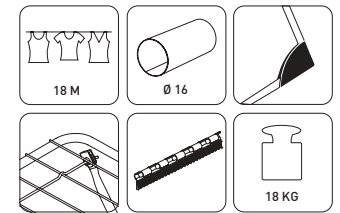

60

WINGS LUX

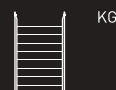
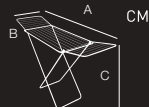

18111

177x55x104

18

55x132

3,4

0,025638667

16

6

20,5x134x56

0,153832

20,80

HERO

18111-10

4 mm
THICK
WIRE

- Completely electrostatic stainless paint
 - Foldable and easy to carry
- 4 mm thick wire for high strength
- Sliding mechanism that facilitates opening and closing
- Plastic apparatus for drying socks
- Wheeled plastic wedge that facilitates movement
- 18 m clothes line hanging capacity
 - 18 kg carrying capacity
 - Warranty 2 years

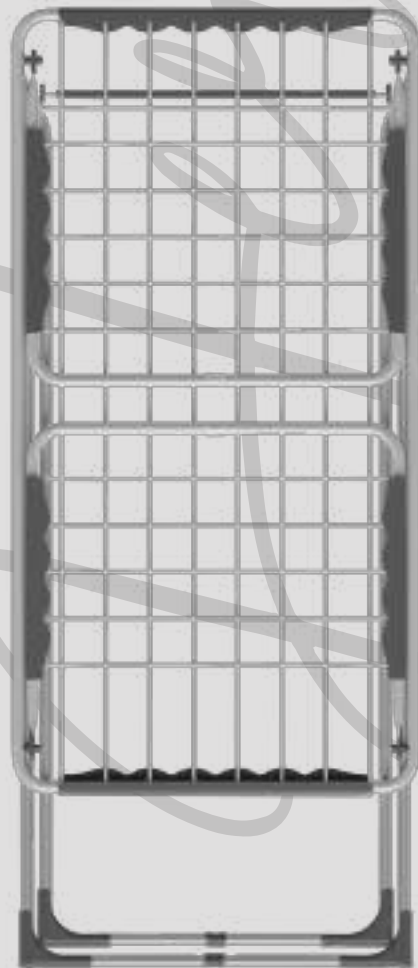
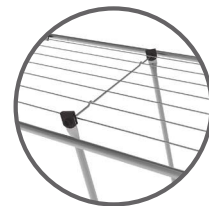
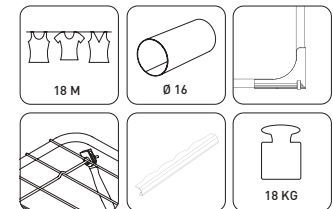

HERO										
18111-01	177x55x104	18	55x132	4.4	0,025638667	16	6	20,5x134x56	0,153832	27,30

WINGS BODRUM

18109

- Completely electrostatic stainless paint
 - Foldable and easy to carry
- Sliding mechanism that facilitates opening and closing
- Plastic apparatus for drying socks
- Plastic caps that prevent slipping
- 18 m clothes line hanging capacity
 - 18 kg carrying capacity
 - Warranty 2 years

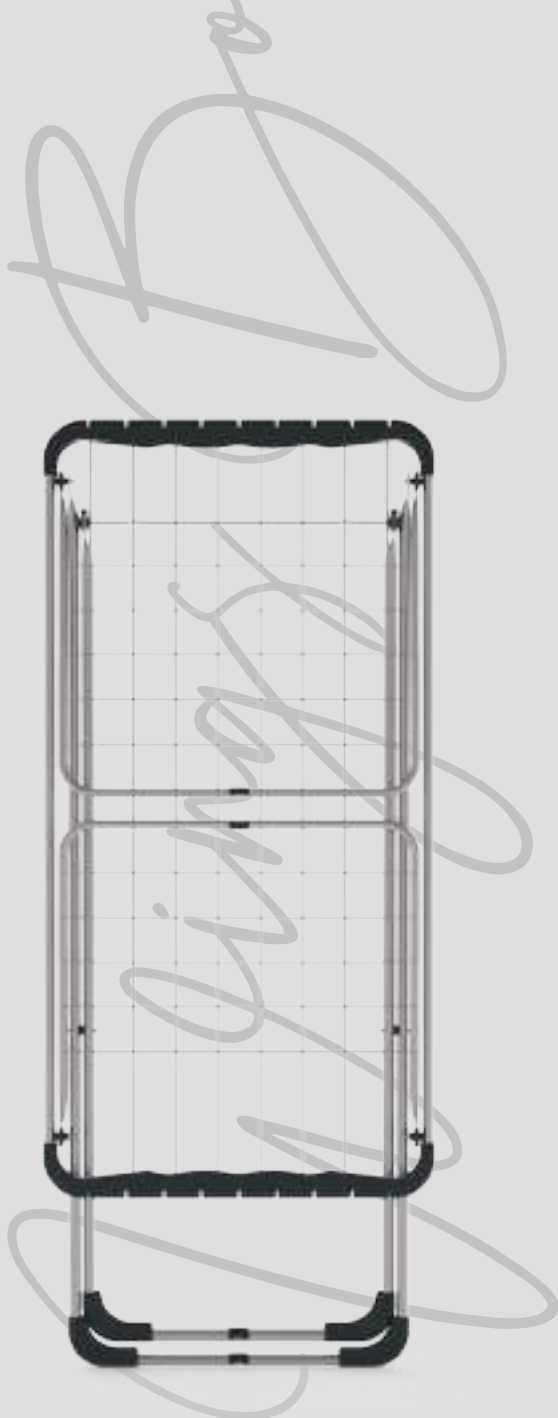
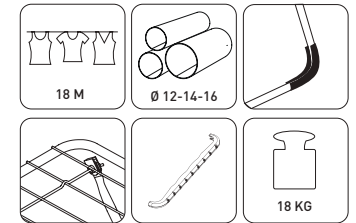

WINGS BODRUM										
18109	178x55x105	18	55x133,5	2,90	0,025064667	12-14-16	6	20,5x131x56	0,150388	17,95

FANTASY LUX

18124-10

- Completely electrostatic stainless paint
 - Foldable and easy to carry
- Plastic apparatus for child security
- Plastic caps that prevent slipping
- 20 m clothes line hanging capacity
 - 20 kg carrying capacity
 - Warranty 2 years

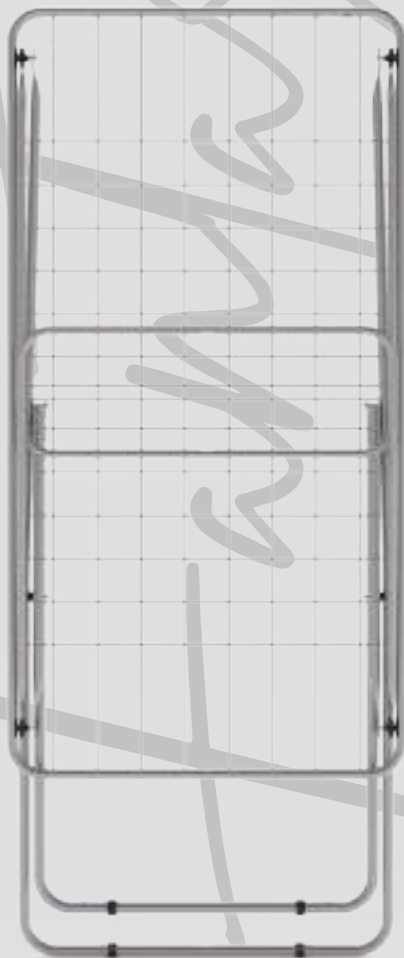
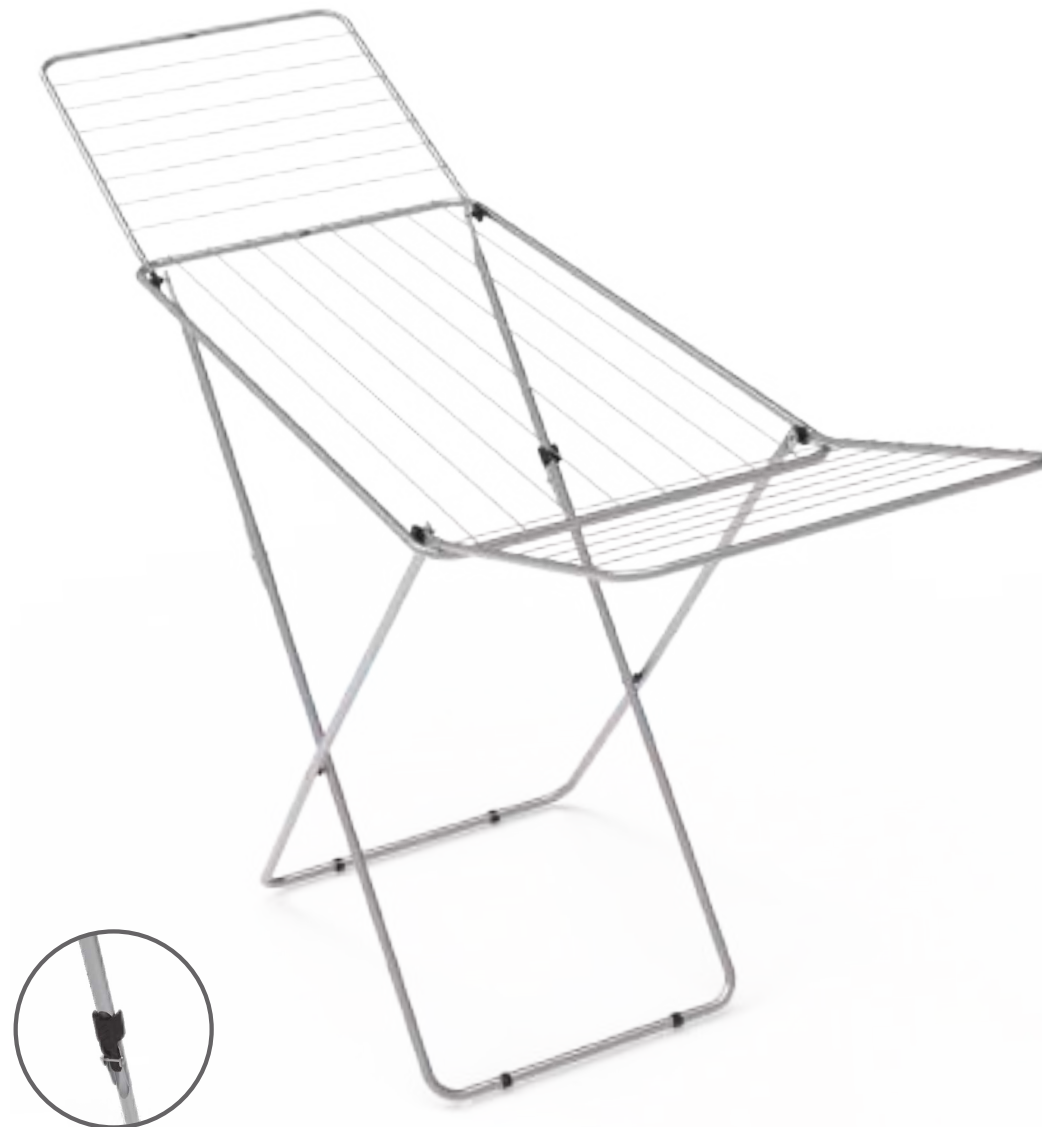
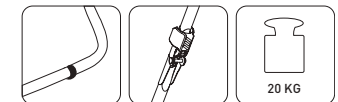
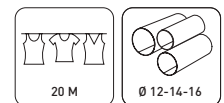

FANTASY LUX	CM	M	CM	KG	M ³	Ø	PCS	CM	M ³	KG
18124-01	198,5x55x110	20	55x129,5	2,80	0,032400667	12-14-16	6	26,5x131x56	0,194404	16,60

FANTASY

18124

- Completely electrostatic stainless paint
 - Foldable and easy to carry
- Sliding mechanism that facilitates opening and closing
- Plastic caps that prevent slipping
- 20 m clothes line hanging capacity
 - 20 kg carrying capacity
 - Warranty 2 years

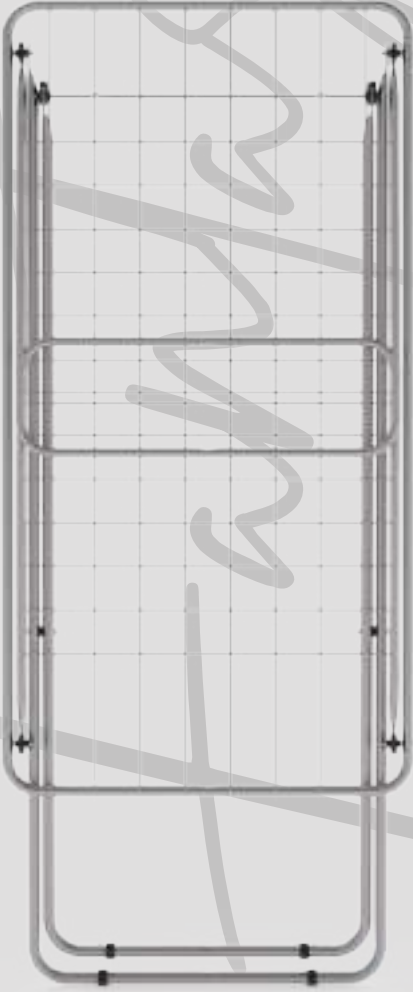
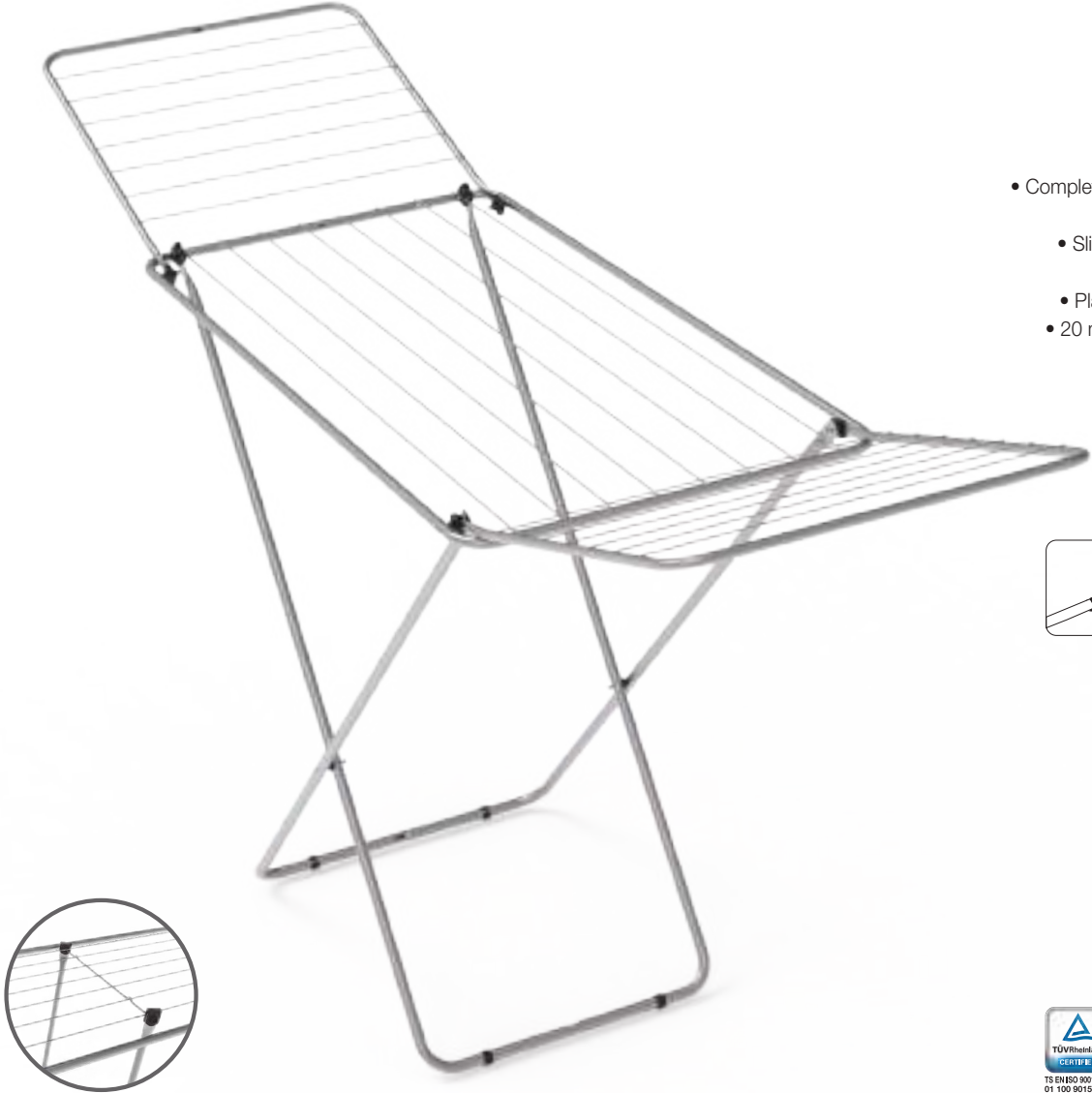
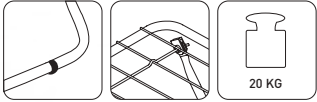
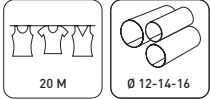

FANTASY										
18124	198,5x55x107	20	55x128,5	2,7	0,026693333	12-14-16	6	22x130x56	0,16016	16,45

AEGEANSTAR LUX

18120-10

- Completely electrostatic stainless paint
 - Foldable and easy to carry
- Plastic apparatus for child security
- Plastic caps that prevent slipping
- 18 m clothes line hanging capacity
 - 18 kg carrying capacity
 - Warranty 2 years

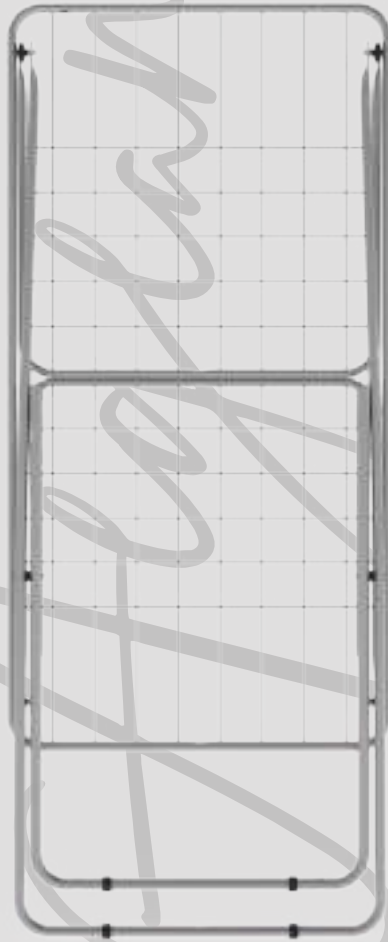
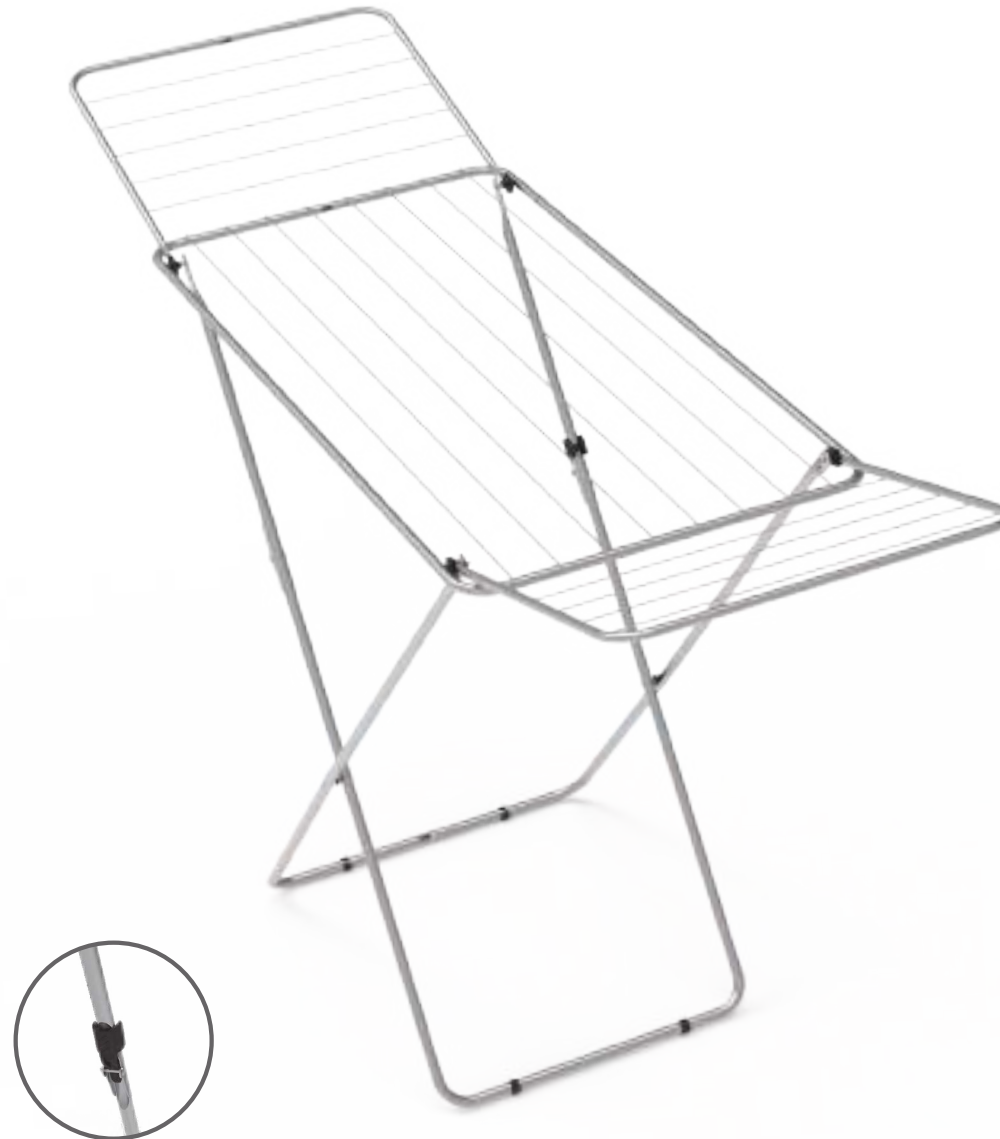
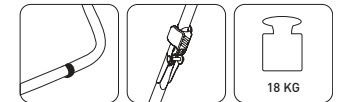
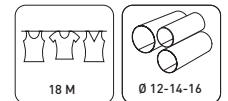

AEGEANSTAR LUX	CM	M	CM	KG	M ³	Ø	PCS	CM	M ³	KG
18124-01	182,5x55x102	18	55x129	2,70	0,018951333	12-14-16	6	15,5x131x56	0,113708	15,90

AEGEANSTAR

18120

- Completely electrostatic stainless paint
 - Foldable and easy to carry
- Sliding mechanism that facilitates opening and closing
- Plastic caps that prevent slipping
 - 18 m clothes line hanging capacity
 - 18 kg carrying capacity
 - Warranty 2 years

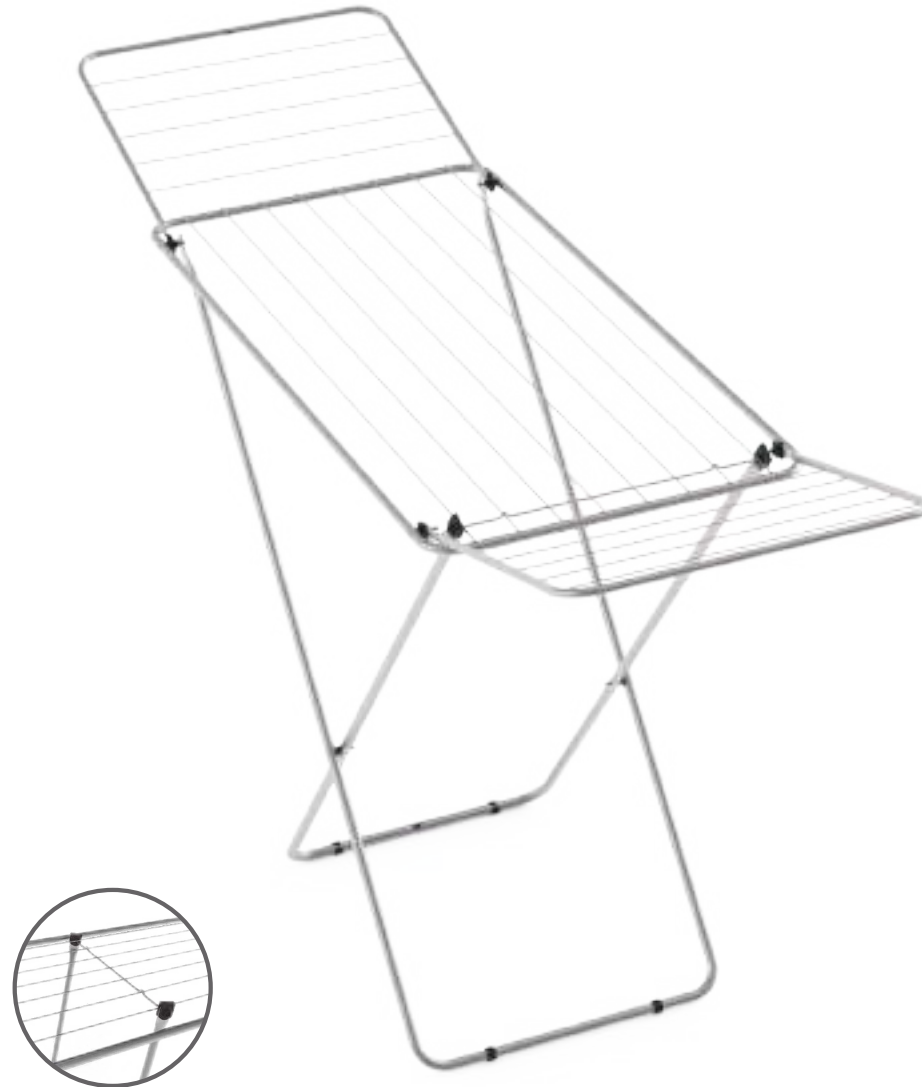
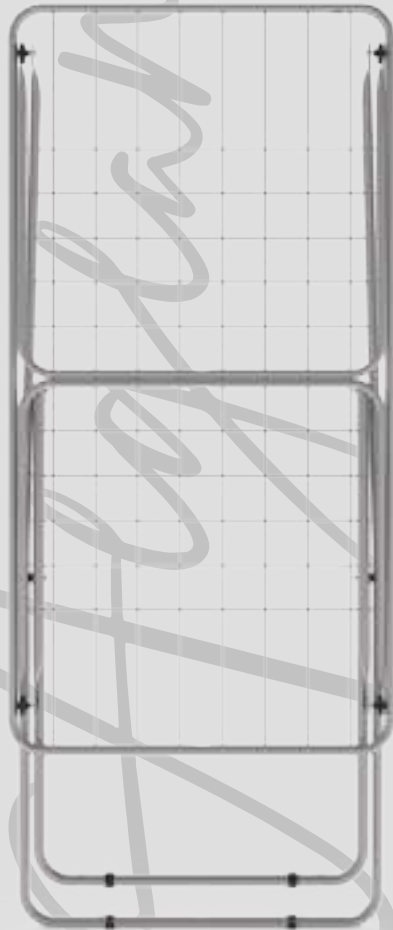
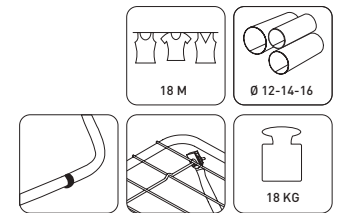

AEGEANSTAR										
18120	182,5x55x102	18	55x128	2,6	0,020485833	12-14-16	6	15,5x130x61	0,122915	15,75

STAR

18121

- Completely electrostatic stainless paint
 - Foldable and easy to carry
- Sliding mechanism that facilitates opening and closing
- Plastic caps that prevent slipping
- 16 m clothes line hanging capacity
 - 16 kg carrying capacity
 - Warranty 2 years

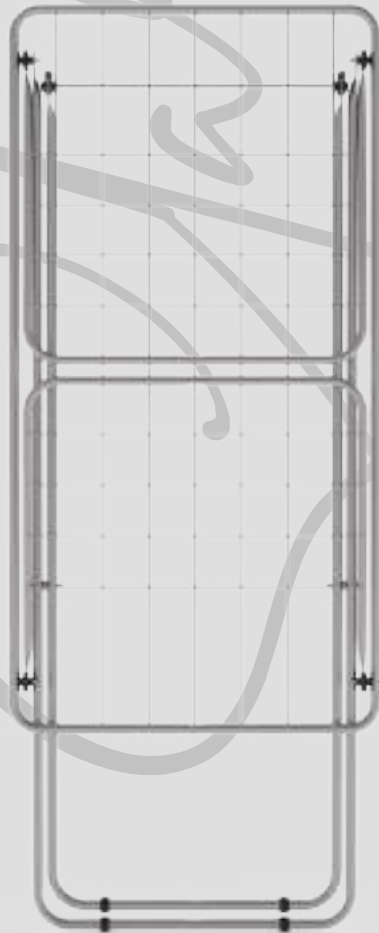
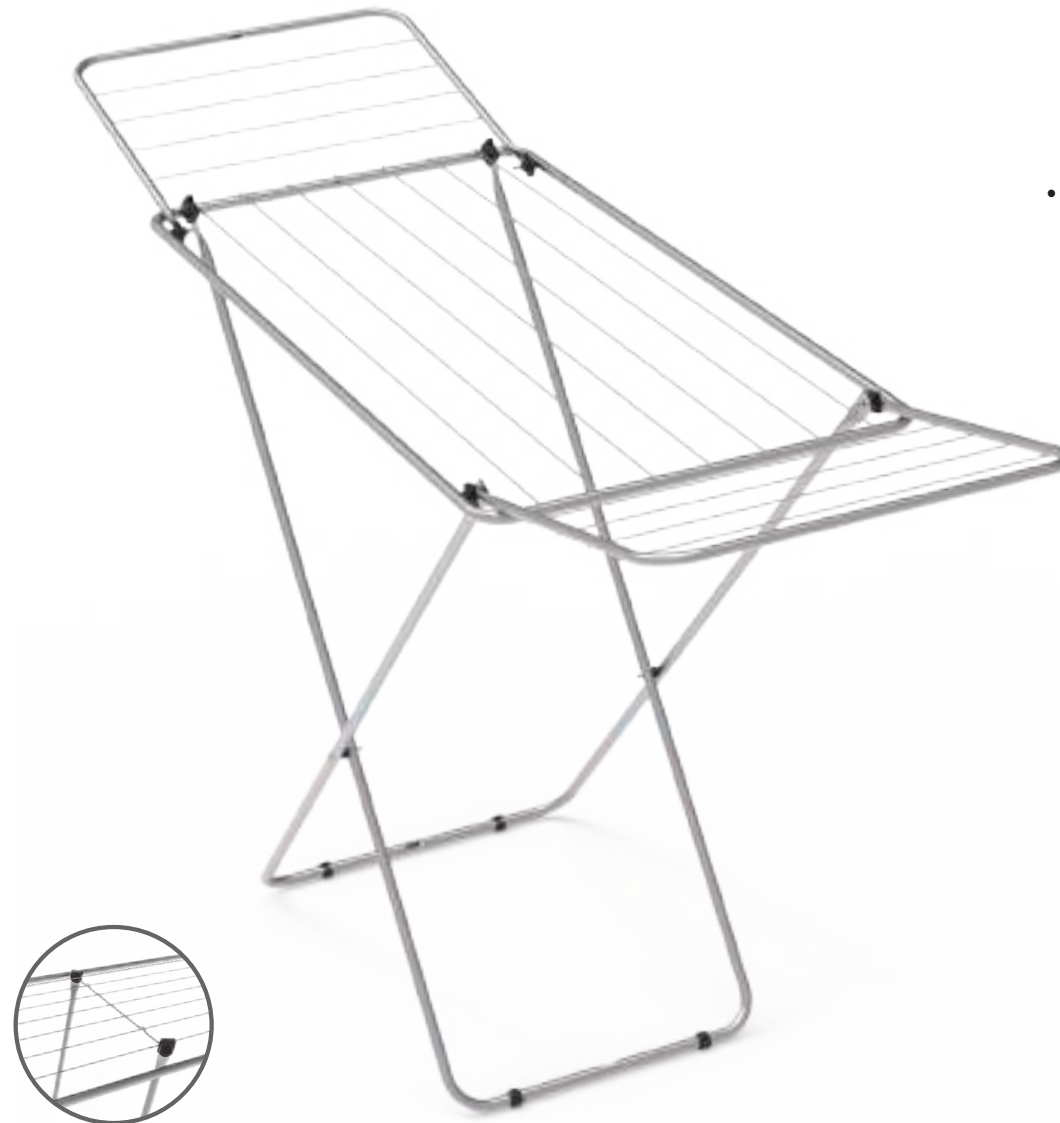
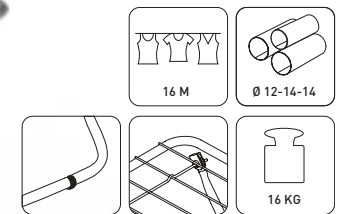

STAR										
18121	164,5x46x96	16	50x123,5	2,1	0,015255208	12-14-14	6	14,5x125x50,5	0,09153125	13,5

UNO

18110

- Completely electrostatic stainless paint
 - Foldable and easy to carry
- Sliding mechanism that facilitates opening and closing
- Plastic caps that prevent slipping
 - 10 m clothes line hanging capacity
 - 10 kg carrying capacity
 - Warranty 2 years

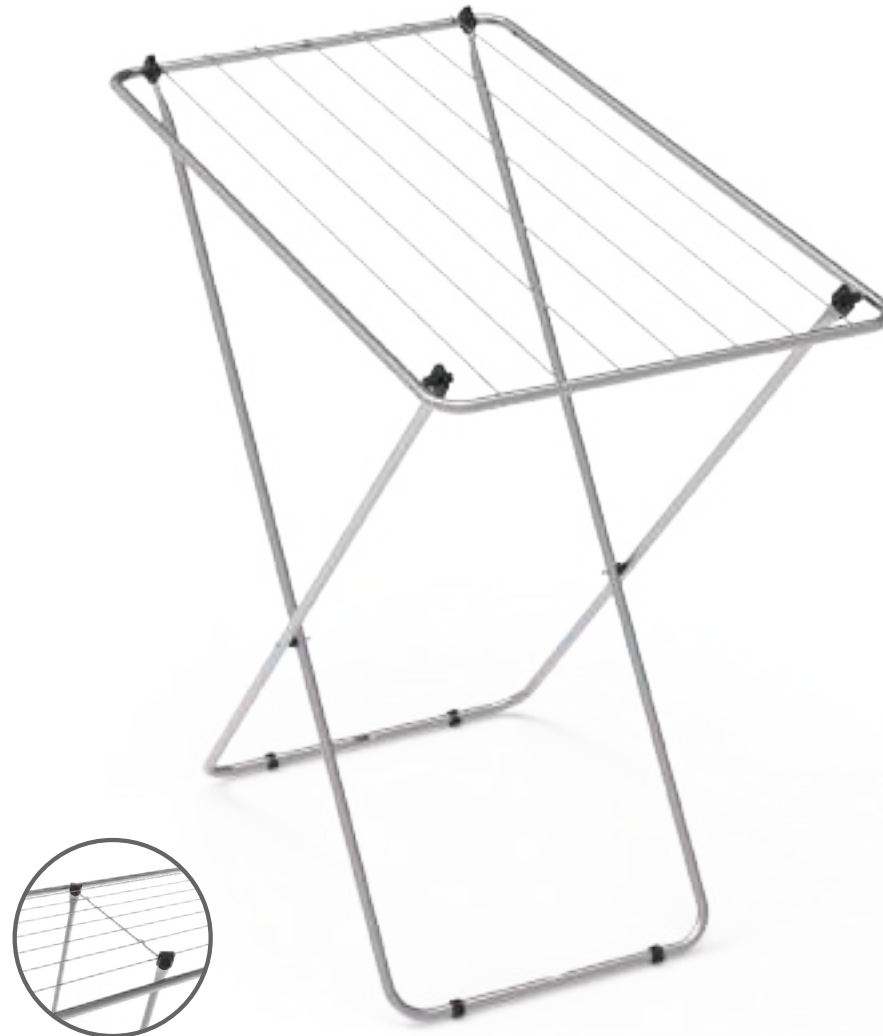
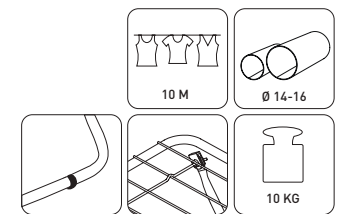

68

UNO										
18110	106x54,5x92,5	10	54,5x131,5	2,3	0,019413333	14-16	6	16x130x56	0,11648	13,75

FLEXY 220

18133

- Completely electrostatic stainless paint
 - Foldable and easy to carry
- Plastic apparatus for drying socks
- Plastic caps that prevent slipping
- 22 m clothes line hanging capacity
 - 22 kg carrying capacity
 - Warranty 2 years

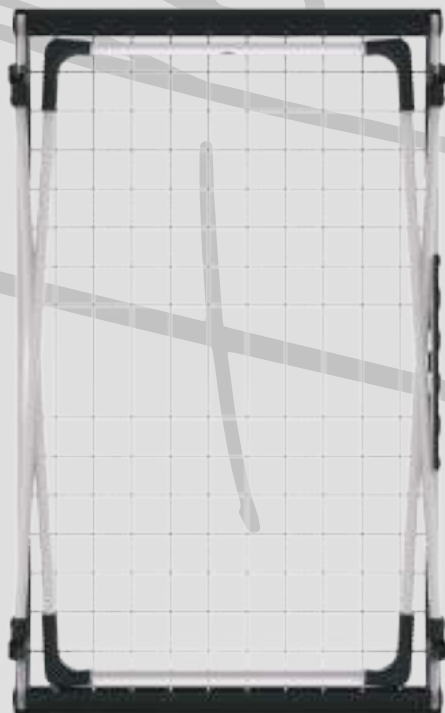
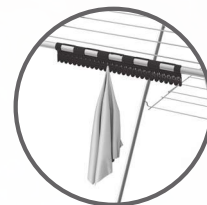
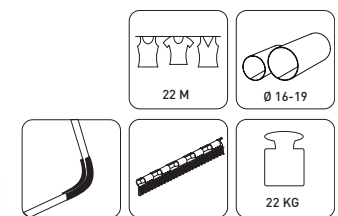

FLEXY 220										
18133	186x66,5x107	22	66,5x107	4,45	0,058528969	16-19	6	31,5x108,5x68,5	0,234115875	17,45

FLEXY 160

18132

- Completely electrostatic stainless paint
 - Foldable and easy to carry
- Plastic apparatus for drying socks
- Plastic caps that prevent slipping
- 16 m clothes line hanging capacity
 - 16 kg carrying capacity
 - Warranty 2 years

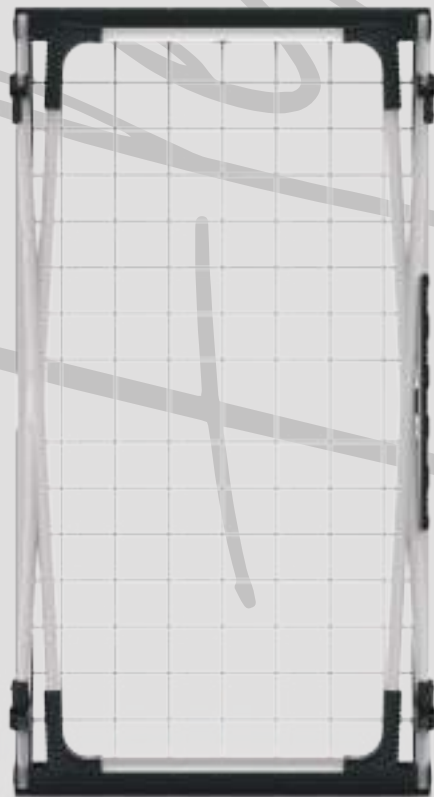
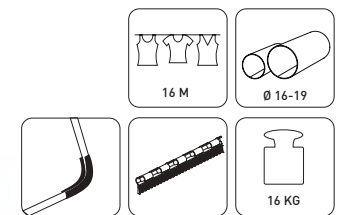

70

FLEXY
160

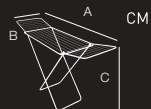

18132

177x54x107

16

54x100

3,9

0,0454

16-19

4

31,5x104x56,5

0,1815

17,30

COSMOS

18130

- Completely electrostatic stainless paint
 - Foldable and easy to carry
- Extra hanging space for small-sized clothes
 - Polyester bag for clothes pegs
 - Wire closing plastic
 - Plastic caps that prevent slipping
- 20 m clothes line hanging capacity
 - 20 kg carrying capacity
 - Warranty 2 years

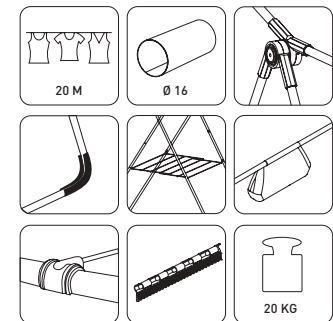

COSMOS	CM	M	CM	KG	M ³	Ø	PCS	CM	M ³	KG
18130	160x60x115	20	59x101	3,4	0,035464	16	6	33x104x62	0,212784	21,80

SMART

18128

- Completely electrostatic stainless paint
 - Foldable and easy to carry
- Extra hanging space for small-sized clothes
 - Polyester bag for clothes pegs
 - Wire closing plastic
- Plastic caps that prevent slipping
- 16 m clothes line hanging capacity
 - 16 kg carrying capacity
 - Warranty 2 years

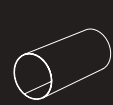
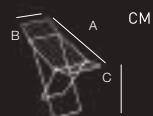
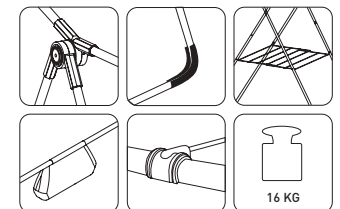
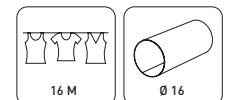

FLORA

18117

- Completely electrostatic stainless paint
 - Foldable and easy to carry
- Extra hanging space for small-sized clothes
 - Polyester bag for clothes pegs
 - Wire closing plastic
- Plastic caps that prevent slipping
- 16 m clothes line hanging capacity
 - 16 kg carrying capacity
 - Warranty 2 years

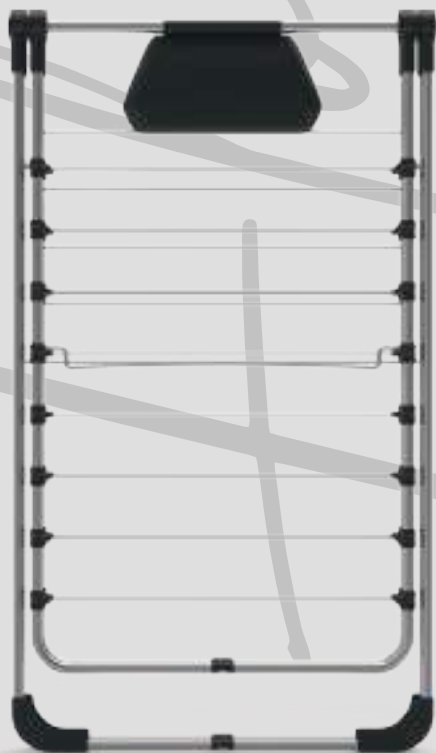
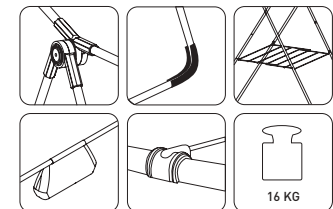

FLORA	CM	M	CM	KG	M ³	Ø	PCS	CM	M ³	KG
18117	159x49,5x118	16	55x98,5	2,7	0,029775375	14	6	31,5x99,5x57	0,17865225	15,90

HANDY

18116

- Completely electrostatic stainless paint
 - Foldable and easy to carry
- Extra hanging space for small-sized clothes
 - Plastic basket for clothes pegs
 - Plastic apparatus for drying socks
 - Plastic caps that prevent slipping
- 20 m clothes line hanging capacity
 - 20 kg carrying capacity
 - Warranty 2 years

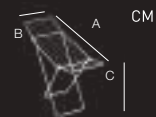
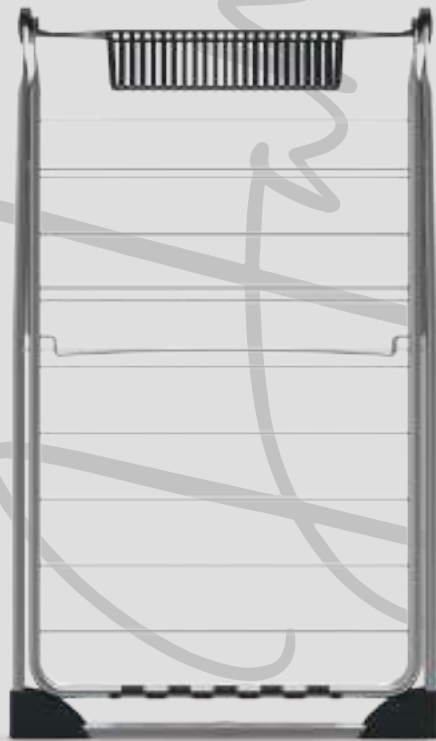
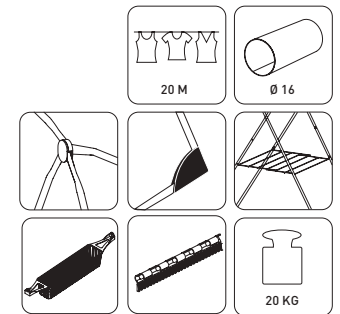

176x54x115,5



20



59,5x102



3,15



0,029553333



16



6



27,5x104x62



0,17732



20,85

CAPRI LUX

18105

- Completely electrostatic stainless paint
- Foldable and easy to carry
- Extra hanging space for small-sized clothes
- Plastic basket for clothes pegs
- Plastic caps that prevent slipping
- 20 m clothes line hanging capacity
- 20 kg carrying capacity
- Warranty 2 years

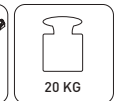
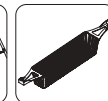
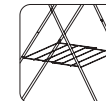
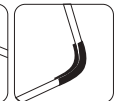
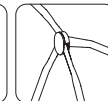
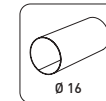
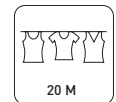

CAPRI LUX	CM	M	CM	KG	M ³	Ø	PCS	CM	M ³	KG
18105	173,5x54,5x115	20	59x102	3,10	0,029553333	16	6	27,5x104x62	0,17732	19,6

CAPRI

18101

- Completely electrostatic stainless paint
 - Foldable and easy to carry
- Extra hanging space for small-sized clothes
 - Plastic caps that prevent slipping
 - 20 m clothes line hanging capacity
 - 20 kg carrying capacity
 - Warranty 2 years

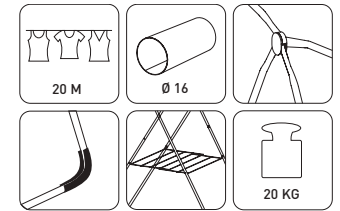

CAPRI										
18101	173,5x54,5x115	20	59x102	2,95	0,029553333	16	6	27,5x104x62	0,17732	19

JUNIOR

18114

- Completely electrostatic stainless paint
 - Foldable and easy to carry
- Extra hanging space for small-sized clothes
 - Plastic caps that prevent slipping
 - 16 m clothes line hanging capacity
 - 16 kg carrying capacity
 - Warranty 2 years

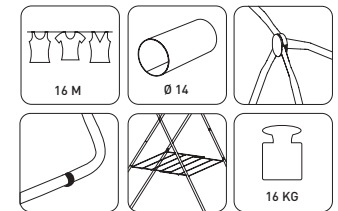

JUNIOR										
18114	171x49,5x89	16	54x98	2,1	0,025049125	14	6	26,5x99,5x57	0,15029475	15,75

SMYRNA

18161

- Completely electrostatic stainless paint
 - Foldable and easy to carry
- Suitable design for using on balcony frame and heater core
 - Distance adjustable carrier arm
- Plastic corner chock against impacts
 - 10 m clothes line hanging capacity
 - 10 kg carrying capacity
 - Warranty 2 years

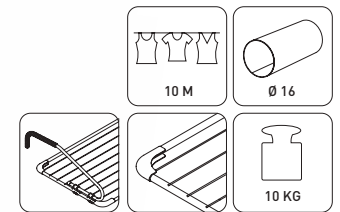

78

SMYRNA

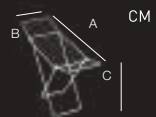

1810

106x55,5x26



10



106x55,5



1,55



0,013980219



16



8



18,5x56,5x107



0,11184175



13,05

THINK

18108

- Completely electrostatic stainless paint
 - Foldable and easy to carry
- Suitable design for using on balcony frame and heater core
 - Distance adjustable carrier arm
- Plastic corner chock against impacts
 - 10 m clothes line hanging capacity
 - 10 kg carrying capacity
 - Warranty 2 years

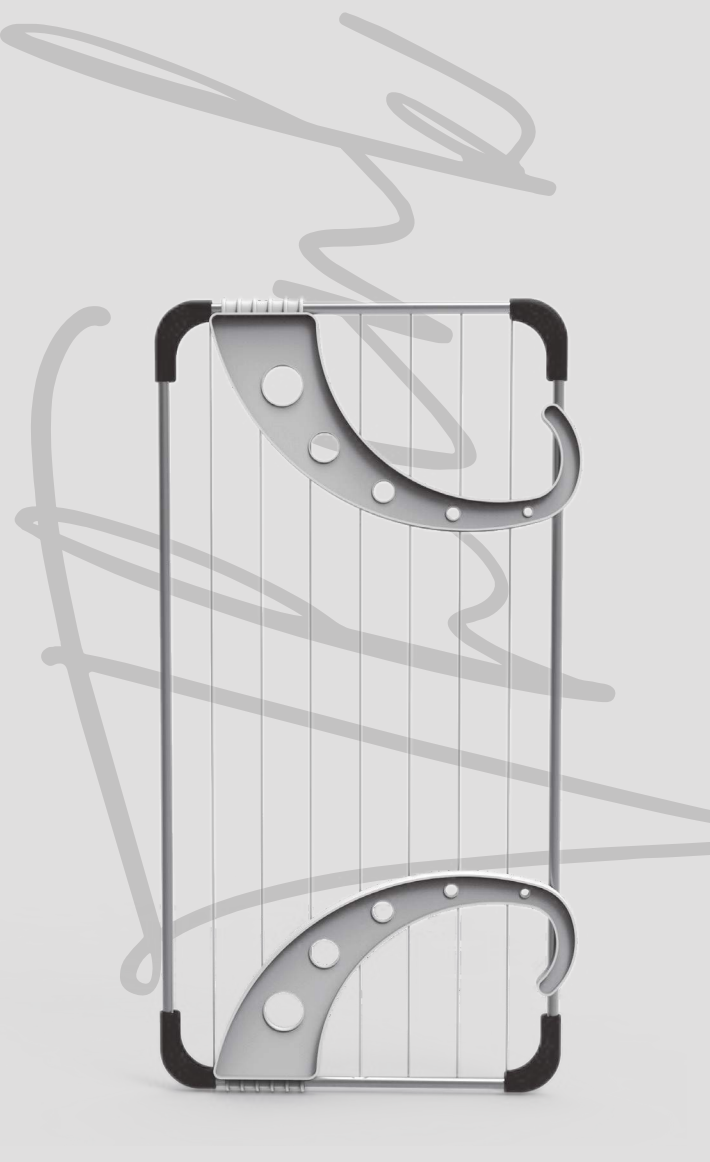
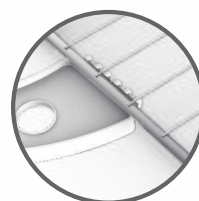
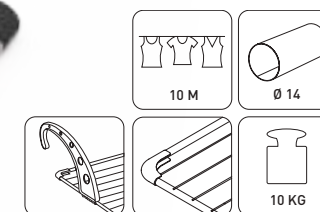

THINK										
18108	107x55,5x28	10	55,5x107	1,37	0,0155601	14	10	56,5x108x25,5	0,1556	13,70

LUNA

18143

- Completely electrostatic stainless paint
 - Foldable and easy to carry
- Suitable design for using on balcony frame and heater core
 - Distance adjustable carrier arm
- 2,5 m clothes line hanging capacity
 - 2,5 kg carrying capacity
 - Warranty 2 years

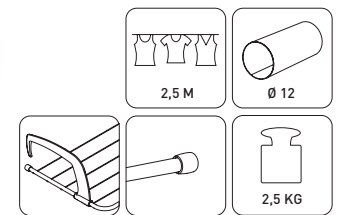

LUNA										
18143	51,5x35,5x14,5	2,5	51,5x35,5	0,35	0,00025844	12	20	35,5x52x28	0,051688	7,20

Tube
DETAILS

A

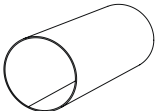

Ø 12

18143 LUNA

B

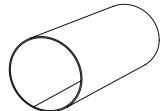

Ø 14

18108 THINK
 18114 JUNIOR
 18117 FLORA

C



Ø 16

18101 CAPRI
 18105 CAPRI LUX
 18111 WINGS LUX
 18111-10 HERO
 18116 HANDY
 18128 SMART
 18130 COSMOS
 18161 SMYRNA
 18137 STREAM 2
 18138 STREAM 3
 18139 STREAM 4

D

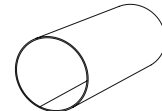

Ø 12-14-14

18121 STAR

E



Ø 12-14-16

18109 WINGS BODRUM
 18120 AEGEANSTAR
 18120-10 AEGEANSTAR LUX
 18124 FANTASY
 18124-10 FANTASY LUX

F

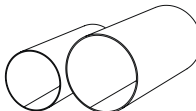

Ø 14-16

18110 UNO
 18142 ISTANBUL LUX

G

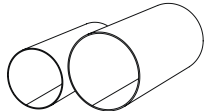

Ø 16-19

18132 FLEXY 160
 18133 FLEXY 220

Cap
DETAILS

A



18110 UNO
18114 JUNIOR
18120 AEGEANSTAR
18120-10 AEGEANSTAR LUX
18121 STAR
18124 FANTASY
18124-10 FANTASY LUX

B



18111 WINGS LUX
18116 HANDY

C

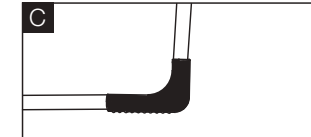

18132 FLEXY 160
18133 FLEXY 220

D

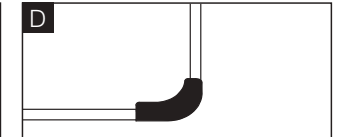

18101 CAPRI
18105 CAPRI LUX
18108 THINK
18109 WINGS BODRUM
18117 FLORA
18128 SMART
18130 COSMOS
18142 ISTANBUL LUX
18161 SMYRNA

E



18137 STREAM 2
18138 STREAM 3
18139 STREAM 4

F

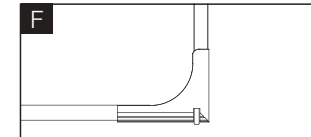

18111-10 HERO

Other
DETAILS

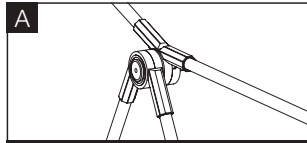

18130 COSMOS
18128 SMART
18117 FLORA

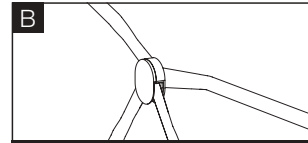

18116 HANDY
18114 JUNIOR
18105 CAPRI LUX
18101 CAPRI

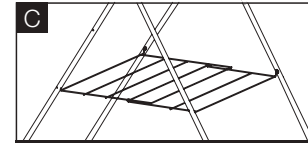

18130 COSMOS
18128 SMART
18117 FLORA
18116 HANDY
18114 JUNIOR
18105 CAPRI LUX
18101 CAPRI

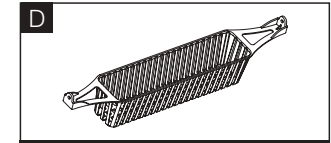

18116 HANDY
18105 CAPRI LUX

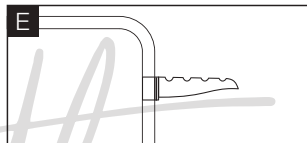

18139 STREAM/4
18138 STREAM/3
18137 STREAM/2

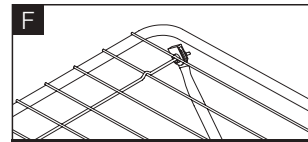

18124 FANTASY
18120 AEGEANSTAR
18121 STAR
18111 WINGS LUX
18111-10 HERO
18110 UNO
18109 WINGS BODRUM

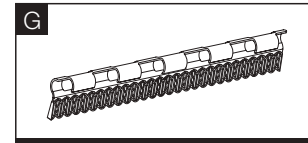

18133 FLEXY 220
18132 FLEXY 160
18131 COSMOS TOWER
18116 HANDY
18111 WINGS LUX

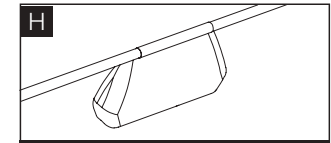

18130 COSMOS
18128 SMART
18117 FLORA

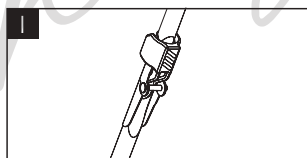

18124-10 FANTASY LUX
18120-10 AEGEANSTAR LUX

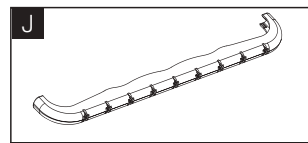

18109 WINGS BODRUM

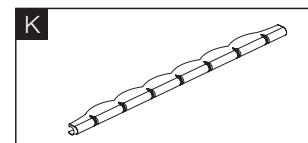

18142 ISTANBUL LUX

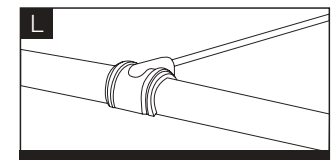

18130 COSMOS
18128 SMART
18117 FLORA

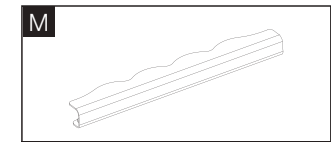

18111-10 HERO

Meters
DETAILS



2,5 M

18143 LUNA



20 M

18124-10 FANTASY LUX
18124 FANTASY
18140 ALUMINIUM
18130 COSMOS
18116 HANDY
18105 CAPRI LUX
18101 CAPRI
18137 STREAM/2



10 M

18110 UNO
18161 SMYRNA
18108 THINK



22 M

18133 FLEXY 220



16 M

18121 STAR
18132 FLEXY 160
18128 SMART
18117 FLORA
18114 JUNIOR



30 M

18138 STREAM/3



18 M









18142 ISTANBUL LUX
18111 WINGS LUX
18111-10 HERO
18109 WINGS BODRUM
18120-10 AEGEANSTAR LUX
18120 AEGEANSTAR



40 M

18139 STREAM/4

Technical DETAILS

PRODUCT CODE	PRODUCT NAME	 CM	 CM	 KG	 M ³	 Ø	 CM	 KG	 M ³	 PCS
18139	STREAM 4	70x70x163,5	163x70	4,75	0,04982445	16	17x167x70,2	19,40	0,1992978	4
18138	STREAM 3	70x70x134	130x71	3,85	0,0400248	16	17x130,8x72	16,40	0,1600992	4
18137	STREAM 2	89x68x68	67,5x90	2,9	0,0277	16	17x91x71,5	15,55	0,1106	4
18142	ISTANBUL LUX	177x51,5x107,5	132x54,5	3,2	0,025638667	14-16	20,5x134x56	20	0,153832	6
18111	WINGS LUX	177x55x104	132x55	3,4	0,025638667	16	20,5x134x56	20,80	0,153832	6
18111-10	HERO	177x55x104	132x55	4,2	0,025064667	16	20,5x134x56	27,30	0,153832	6
18109	WINGS BODRUM	178x55x105	133,5x55	2,9	0,032400667	12-14-16	20,5x131x56	17,95	0,150388	6
18124-10	FANTASY LUX	198,5x55,110	129,5x55	2,8	0,026693333	12-14-16	26,5x131x56	16,6	0,194404	6
18124	FANTASY	198,5x55x107	128,5x55	2,7	0,018951333	12-14-16	22x130x56	16,45	0,16016	6
18120-10	AEGEANSTAR LUX	182,5x55x102	129x55	2,7	0,020485833	12-14-16	15,5x131,56	15,90	0,113708	6
18120	AEGEANSTAR	182,5x55x102	128x55	2,6	0,015255208	12-14-16	15,5x130x61	15,75	0,122915	6
18121	STAR	164,5x46x96	123,5x50	2,1	0,019413333	12-14-14	14,5x125x50,5	13,50	0,09153125	6
18110	UNO	106x54,5x92,5	131,5x54,5	2,3	0,058528969	14-16	16x130x56	13,75	0,11648	6
18133	FLEXY 220	186x66,5x107	107x66,5	4,45	0,045383625	16-19	31,5x108,5x68,5	19,40	0,234115875	4
18132	FLEXY 160	177x54x107	101x54	3,85	0,035464	16-19	31,5x102,56,5	17,35	0,1815345	4
18130	COSMOS	160x60x115	59x101	3,4	0,029775375	16	33x104x62	21,80	0,212784	6
18128	SMART	167x49,5x97	98x54,5	2,9	0,029775375	16	31,5x99,5x57	18,48	0,17865225	6
18117	FLORA	159x49,5x118	98,5x55	2,7	0,029553333	14	31,5x99,5x57	15,90	0,17865225	6
18116	HANDY	176x54x115,5	102x59	3,15	0,029553333	16	27,5x104x62	20,85	0,17732	6
18105	CAPRI LUX	173,5x54,5x115	102x59	3,1	0,029553333	16	27,5x104x62	19,60	0,17732	6
18101	CAPRI	173,5x54,5x115	102x59	2,95	0,025049125	16	27,5x104x62	19	0,17732	6
18114	JUNIOR	171x49,5x89	98,54	2,1	0,013980219	14	26,5x99,5x57	15,75	0,15029475	6
18161	SMYRNA	106x55,5x26	106,55,5	1,55	0,0155601	16	18,5x56,5x107	13,05	0,11184175	8
18108	THINK	107x55,5x28	107,55,5	1,37	0,0025844	14	56,5x108x25,5	13,70	0,155601	10
18143	LUNA	51,5x31,5x14,5	51,5x35,5	0,35		14	35,5x52x28	7,20	0,051688	20

Camping Assortment

Assortiment



SUNSHINE

SWING CHAIR

18680



- Completely electrostatic stainless paint
 - Safe usage for max. 3 people
 - Weight capacity of 180 kg.
 - Colourful, bright fabric with %50 cotton %50 Polyester
 - High quality foam with no deformation
 - Plastic piece to prevent slipping
 - Easy carriage of packed item
 - Strong carton box
 - Easy installation

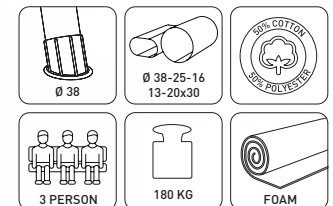

88

SUNSHINE



175x110x151



21,1



3

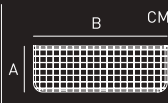

43x130



14



38-25-16-13-20x30



1



18,5x174x54,5



0,1754355



21,1

TITO

BIG CAMPING CHAIR 18638

- Completely electrostatic stainless paint
- Bright, Colorful, %100 Polyester fabric
- 10 mm sponge between 2 layers of fabric
 - Mesh side bag
- Locked with stopper, with hanger, polyester carrying bag
 - Cup holder at the right side
 - Anti-Slip plastic wedge
 - Suitable for open area uses
 - Stitch strength with special bias tape
 - 110 kgs carrying capacity



COLOR



TITO										
18638	101x50x95	47x51x60x44	21x21x94	3,65	0,0173	16	4	28x95x26	0,06916	15,45

RETRO

WOODEN SLEEVE BEACH CHAIR 18658

- Completely electrostatic stainless paint
 - Foldable and easy to carry
- Bright, Colorful, %100 polyester fabric
 - Stitch strength with special bias tape
 - Anti-Slip plastic wedge
- Suitable for open area uses
 - Wood armrest
- 110 kgs carrying capacity

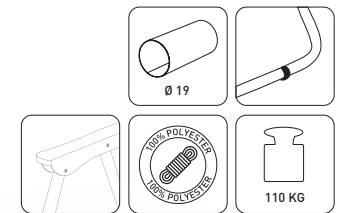

90

RETRO

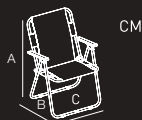

CM



CM



CM



KG



M³

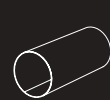

Ø



PCS



CM



M³



KG

18658

80x40x56

49x40x49

40x49

2,6

14

19

6

38,5x58,5x720

0,0270

16,2







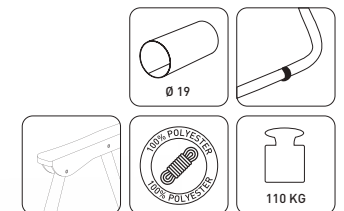

SPORCO

WOODEN SLEEVE PICNIC CHAIR 18645

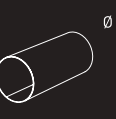

- Completely electrostatic stainless paint
 - Foldable and easy to carry
- Bright, Colorful, %100 polyester fabric
 - Stitch strength with special bias tape
 - Anti-Slip plastic wedge
- Suitable for open area uses
 - Wood armrest
- 110 kgs carrying capacity

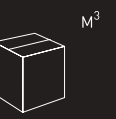

SPORCO	 CM	 CM	 CM	 KG	 M ³	 Ø	 PCS	 CM	 M ³	 KG
18645	80x40x56	49x40x49	40x49	2,6	14	19	6	38,5x58,5x720	0,0270	16,2

NARIO

PATTERNED CAMPING CHAIR

18632

- Completely electrostatic stainless paint
- Bright, Colorful, %100 Polyester fabric
 - Locked with stopper, with hanger, polyester carrying bag
 - Cup holder at the right side
 - Anti-Slip plastic wedge
 - Suitable for open area uses
- Stitch strength with special bias tape
 - 110 kgs carrying capacity

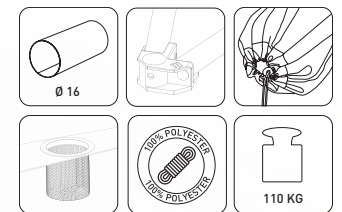

NARIO												
18632	80x51x74	40x51x51x41	21x21x94	2,03	0,0108	16	8	24,5x84x42	0,086436	17,3		

PALIO

CAMPING CHAIR 18610

- Completely electrostatic stainless paint
- Bright, Colorful, %100 Polyester fabric
 - Locked with stopper, with hanger, polyester carrying bag
- Cup holder at the right side
 - Anti-Slip plastic wedge
- Suitable for open area uses
 - Stitch strength with special bias tape
- 110 kgs carrying capacity

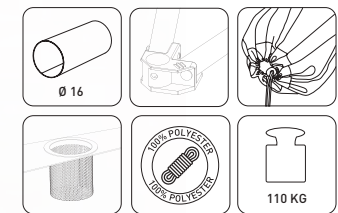

PALIO										
18610	80x51x74	40x51x51x41	21x21x94	2,03	0,0108	16	8	24,5x84x42	0,086436	17,3

LUCCO

PATTERNED CAMPING CHAIR WITH HANGER

18636

- Completely electrostatic stainless paint
- Bright, Colorful, %100 Polyester fabric
 - Hanger to carry
 - Mesh side bag
- Cup holder at the right side
 - Anti-Slip plastic wedge
- Suitable for open area uses
 - Stitch strength with special bias tape
- 110 kgs carrying capacity

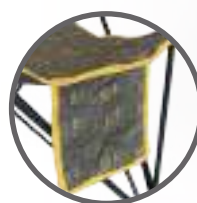
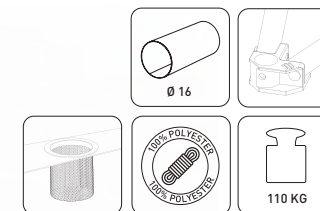

LUCCO										
18636	78x51x74	40x51x51x41	21x21x94	2	0,0102	16	6	24x79,5x32	0,061056	13

DANTE

CAMPING CHAIR WITH HANGER 18618

- Completely electrostatic stainless paint
- Bright, Colorful, %100 Polyester fabric
 - Hanger to carry
- Cup holder at the right side
 - Anti-Slip plastic wedge
- Suitable for open area uses
 - Stitch strength with special bias tape
- 110 kgs carrying capacity

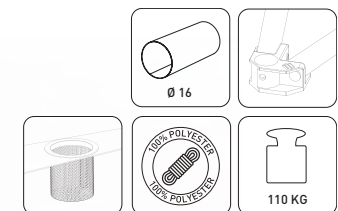

DANTE										
18618	78x51x74	40x51x51x41	21x21x94	2	0,0102	16	6	24x79,5x32	0,061056	13

PARMA

ECO CAMPING CHAIR

18622

- Completely electrostatic stainless paint
- Bright, Colorful, %100 Polyester fabric
 - Hanger to carry
 - Anti-Slip plastic wedge
- Suitable for open area uses
 - Stitch strength with special bias tape
- 110 kgs carrying capacity

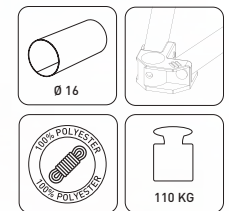

96

PARMA

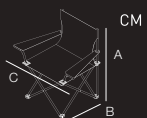

CM

78x51x51



CM

40x51x51x41



CM

21x21x94



KG

1,7



M³

0,0075

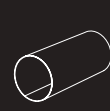

Ø

16



PCS

8

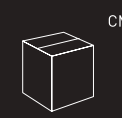

CM

21x77,5x37



M³

0,0602175



KG

14,6

PAPSY

FUN KIDS CAMPING CHAIR 18626

- Completely electrostatic stainless paint
- Bright, Colorful, %100 Polyester fabric
 - Locked with stopper, with hanger, polyester carrying bag
 - Anti-Slip plastic wedge
 - Suitable for open area uses
- Stitch strength with special bias tape
 - 50 kgs carrying capacity

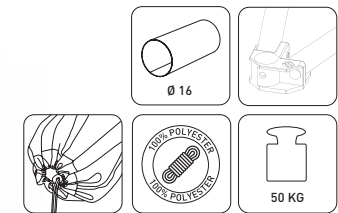

PAPSY										
18626	67x29x57	38x25x32x29	14x9x59	1,13	0,0072	16	4	21x65x21	0,028665	5,5

FISHER

STOOL WITH BACK

18668

- Completely electrostatic stainless paint
- Bright, Colorful, %100 Polyester fabric
 - Large backrest
 - Anti-Slip plastic wedge
 - Suitable for open area uses
- Stitch strength with special bias tape
 - 100 kgs carrying capacity

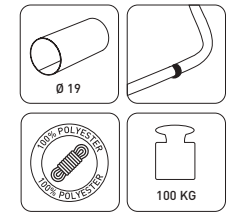

98

FISHER

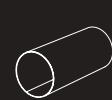
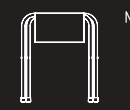
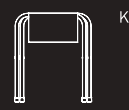
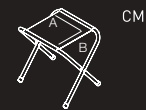
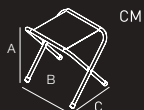

18650

38x32x68

31x30,5x20x37

32x38

1,13

0,0066

19

10

44X52X29

0,0664

12,30





GIAN

BIG STOOL

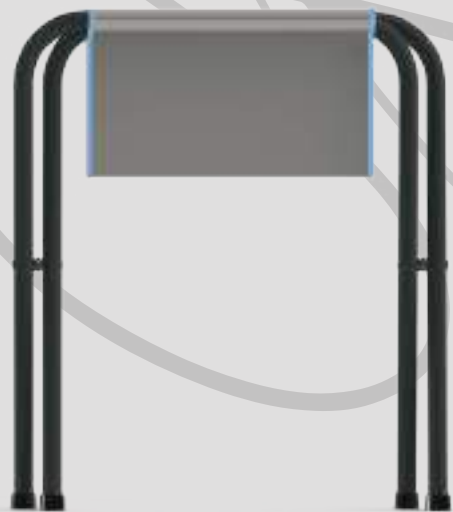
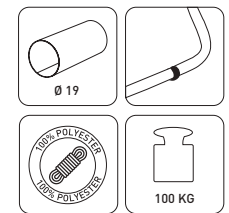
18660

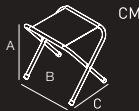
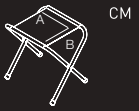
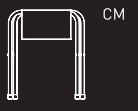
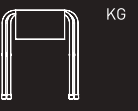
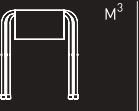
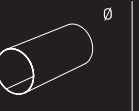
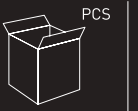
- Completely electrostatic stainless paint
- Bright, Colorful, %100 Polyester fabric
 - Anti-Slip plastic wedge
 - Suitable for open area uses
- Stitch strength with special bias tape
 - 100 kgs carrying capacity

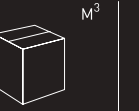

GIA	 CM	 CM	 CM	 KG	 M ³	 Ø	 PCS	 CM	 M ³	 KG
18660	42,5x32x39	30x30	32	1,05	0,0075	19	8	42x52x27,5	0,0601	9,40

TINO

SMALL STOOL

18664

- Completely electrostatic stainless paint
- Bright, Colorful, %100 Polyester fabric
 - Anti-Slip plastic wedge
 - Suitable for open area uses
- Stitch strength with special bias tape
 - 100 kgs carrying capacity

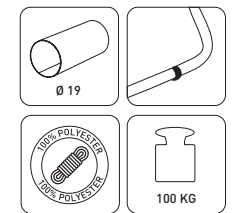

100

TINO

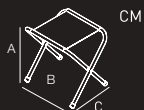

CM

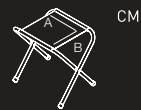

CM



CM



KG



M³



Ø



PCS



CM



M³



KG

18664

35,5x27,6x34,8

32x34

35,5x34,8

0,730

0,0038

19

8

41x48,5x15,2

0,0302

8

Tube
DETAILS

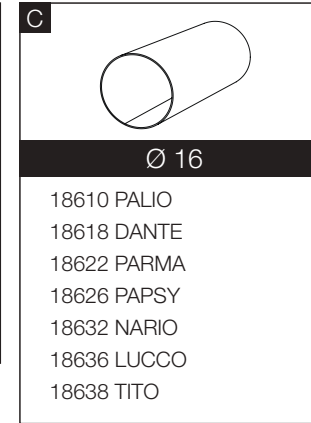
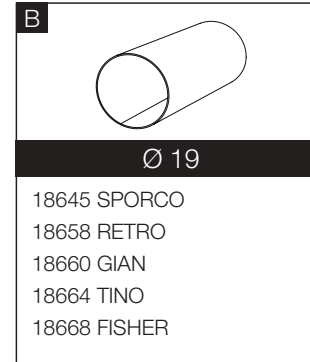
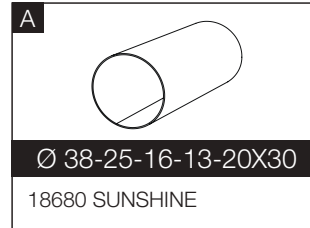



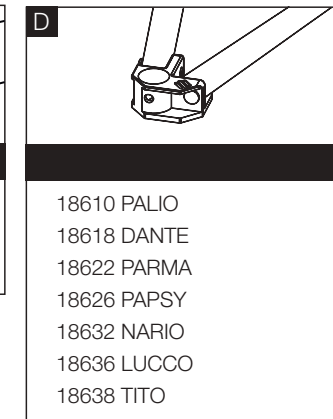
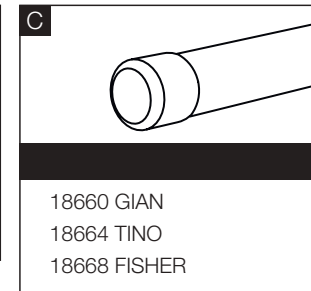
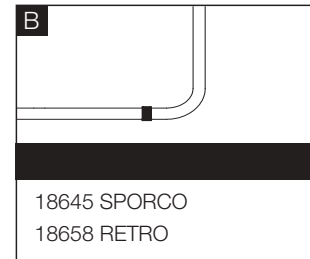
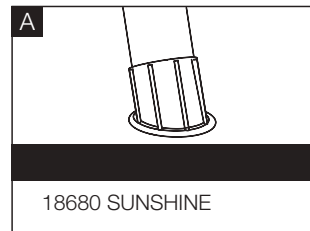



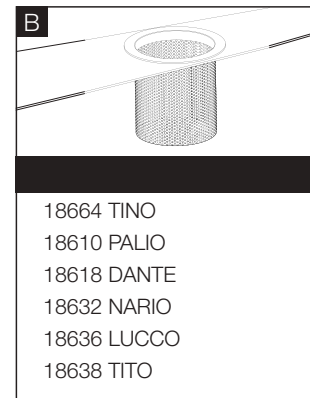
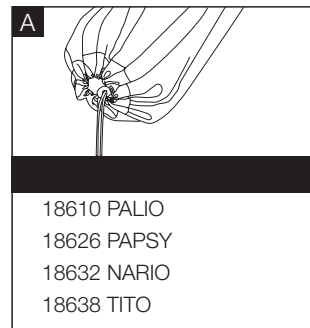



Cap
DETAILS























Other
DETAILS













Technical DETAILS

PRODUCT CODE	PRODUCT NAME	 CM	 KG	 CM	 PERSON	 DNS	 Ø	 CM	 KG	 M ³	 PCS
18680	SUNSHINE	175x110x151	21,1	43x130	3	14	38-25-16-13-20x30	18,5x174x54,5	22,2	0,1754355	1

PRODUCT CODE	PRODUCT NAME	 CM	 CM	 CM	 KG	 M ³	 Ø	 CM	 KG	 M ³	 PCS
18658	RETRO	80x40x56	49x40x49	40x49	2,6	14	19	38,5x58,5x72	16,2	0,0270	6
18645	SPORCO	80x40x56	49x40x49	40x49	2,6	14	19	38,5x58,5x72	16,2	0,0270	6

PRODUCT CODE	PRODUCT NAME	 CM	 CM	 CM	 KG	 M ³	 Ø	 CM	 KG	 M ³	 PCS
18610	PALIO	80x51x74	40x51x51x41	21x21x94	2,03	0,0108	16	24,5x84x42	17,3	0,086436	8
18618	DANTE	78x51x74	40x51x51x41	21x21x94	2	0,0102	16	24x79,5x32	13	0,061056	6
18622	PARMA	78x51x51	40x51x51x41	21x21x94	1,7	0,0075	16	21x77,5x37	14,6	0,0602175	8
18626	PAPSY	67x29x57	38x25x32x29	14x9x59	1,13	0,0072	16	21x65x21	5,5	0,028665	4
18632	NARIO	80x51x74	40x51x51x41	21x21x94	2,03	0,0108	16	24,5x84x42	17,3	0,086436	8
18636	LUCCO	78x51x74	40x51x51x41	21x21x94	2	0,0102	16	24x79,5x32	13	0,061056	6
18638	TITO	101x50x95	47x51x60x44	21x21x94	3,65	0,0173	16	28x95x26	15,45	0,06916	4

PRODUCT CODE	PRODUCT NAME	 CM	 CM	 CM	 KG	 M ³	 Ø	 CM	 KG	 M ³	 PCS
18660	GIA	42,5x32x39	30x30	42,5x32	1,05	0,0075	19	42x52x27,5	9,40	0,0601	8
18664	TINO	35,5x27,5x34,8	32x34	35,5x34,8	0,730	0,0038	19	41x48,5x15,2	8	0,0302	8
18668	FISHER	38x32x68	31x30,5x20x37	31x37	1,13	0,0066	19	44x52x29	12,30	0,0664	10

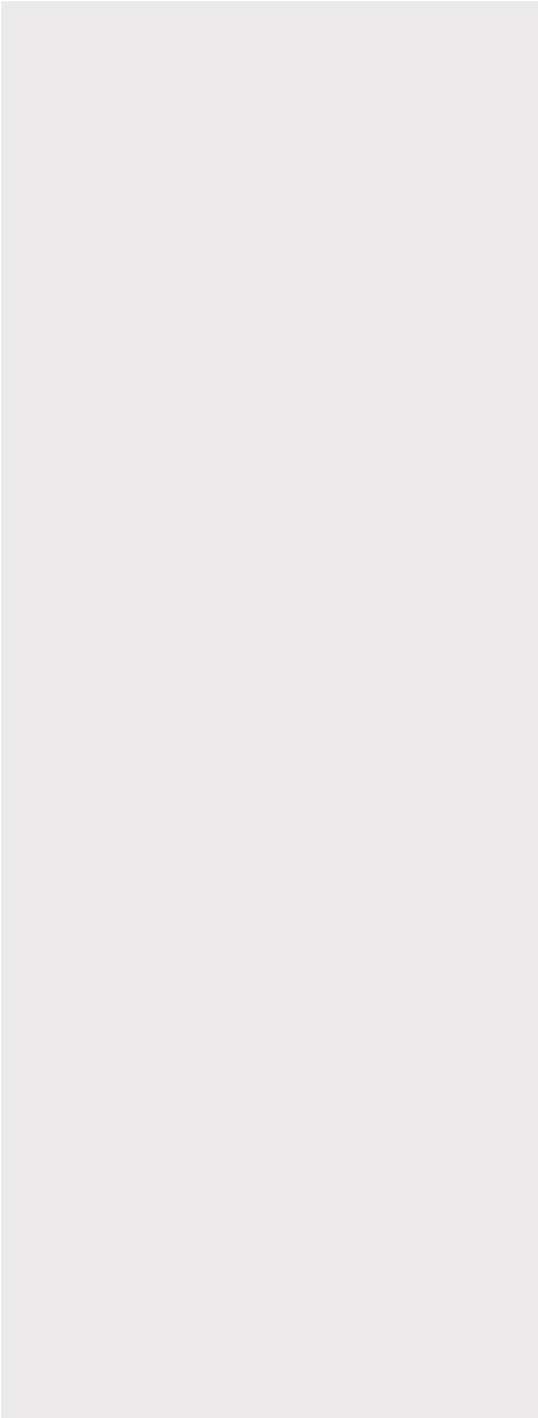

Other Products

Product



SUPER MASTER-2

18502



- Completely electrostatic stainless paint
 - Foldable and easy to carry
- Height possibility till 45 cm from floor to top step
 - Secure deploy limit
- Plastic corner piece to prevent slipping
- Embossments on steps to avoid slipping
 - Curled inner metal step to prevent cut and tearing injuries
- Max carrying capacity 100 kg
 - Warranty 2 years

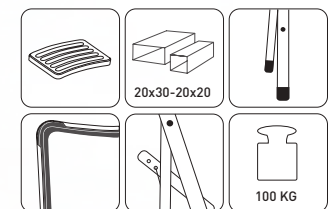

106

SUPER MASTER 2



CM

51x80



CM

30x22,5



CM

48x89



KG

3,9

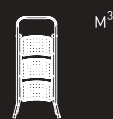

M³

0,022625



Ø

20x30-20x20



PCS

4



CM

20x90,5x50



M³

0,0905



KG

15,60





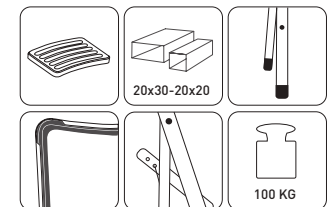

SUPER MASTER-3

18503



- Completely electrostatic stainless paint
 - Foldable and easy to carry
- Height possibility till 65 cm from floor to top step
 - Secure deploy limit
- Plastic corner piece to prevent slipping
- Embossments on steps to avoid slipping
 - Curled inner metal step to prevent cut and tearing injuries
- Max carrying capacity 100 kg
 - Warranty 2 years

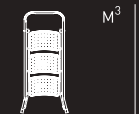
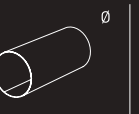
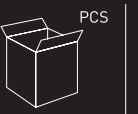
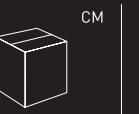
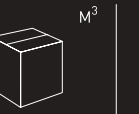

SUPER MASTER 3	 CM	 CM	 CM	 KG	 M ³	 Ø	 PCS	 CM	 M ³	 KG
18503	62x106	30x22,5	48x114,5	5,2	0,02875	20x30-20x20	4	20x115x50	0,115	20,90

SUPER MASTER-4

18504

- Completely electrostatic stainless paint
 - Foldable and easy to carry
- Height possibility till 90 cm from floor to top step
 - Secure deploy limit
- Plastic corner piece to prevent slipping
- Embossments on steps to avoid slipping
 - Curled inner metal step to prevent cut and tearing injuries
- Max carrying capacity 100 kg
 - Warranty 2 years

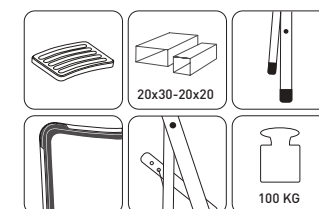

108

SUPER MASTER 4										
18504	89x127	30x22,5	48x140	6,775	0,03525	20x30-20x20	4	20x141x50	0,141	27,10

LUCCA

LUCCA 1

SHOPPING TROLLEY 18001



- All metal parts are electrostatic stainless paint
 - Large internal volume
 - PVC waterproof fabric
 - Folding feature from the feet
- The plastic wedge that prevents slipping on the support leg
 - Lightweight utility hand truck
- Plastic caps that prevent slipping
 - Easy and quiet transport by EVA wheels (Ethylene Vinyl Acetate)
- Durable plastic parts fastened with rivets
 - 30 kg carrying capacity
 - Warranty 2 years

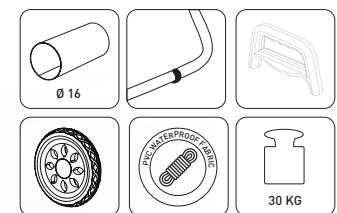

LUCCA 1		CM		CM		KG		M ³		Ø		PCS		CM		M ³		KG
18001	36x28x91		36x14x91		1,62		0,0115368		16		10		33x92x38		0,1115368		16,2	



LUCCA 2

SHOPPING TROLLEY 18002



- All metal parts are electrostatic stainless paint
 - Large internal volume
 - PVC waterproof fabric
- Folding feature from the feet
- The plastic wedge that prevents slipping on the support leg
- Lightweight utility hand truck
 - Plastic caps that prevent slipping
 - Easy and quiet transport by EVA wheels (Ethylene Vinyl Acetate)
- Durable plastic parts fastened with rivets
 - 30 kg carrying capacity
 - Warranty 2 years

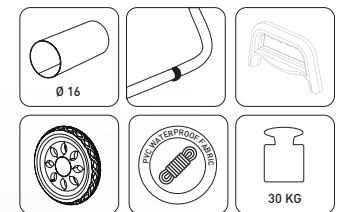

LUCCA 2		CM		CM		KG		M ³		Ø		PCS		CM		M ³		KG
18002	36x28x91		36x14x91		1,62		0,0115368		16		10		33x92x38		0,1115368		16,2	

LUCCA

LUCCA 3

SHOPPING TROLLEY 18003

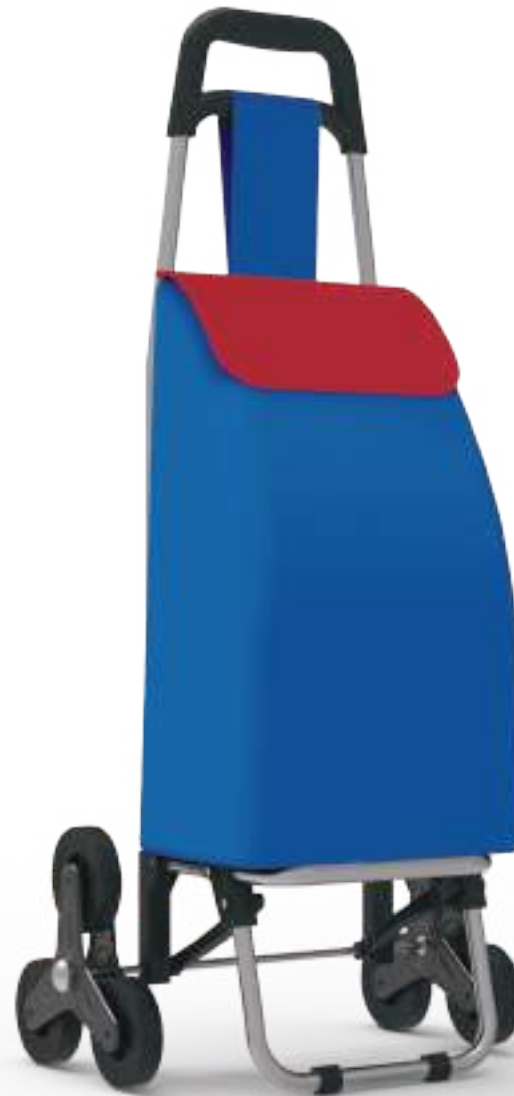

- All metal parts are electrostatic stainless paint
 - Large internal volume
 - PVC waterproof fabric
- Folding feature from the feet
- The plastic wedge that prevents slipping on the support leg
 - Lightweight utility hand truck
 - Plastic caps that prevent slipping
- Triple EVA (Ethylene Vinyl Acetate) wheels that can easily pass the stairs and pavements and do not make any noise
- Durable plastic parts fastened with rivets
- The triple wheel can easily cross stairs and sidewalks
 - 30 kg carrying capacity
 - Warranty 2 years

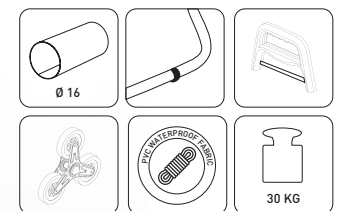

LUCCA 3		CM		CM		KG		M ³		Ø		PCS		CM		M ³		KG
18003	36x28x91		36x14x91		1,62		0,0115368		16		10		33x92x38		0,1115368		16,2	

Tube

DETAILS

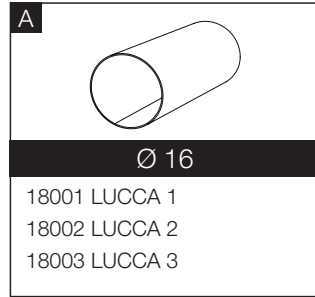

Cap

DETAILS

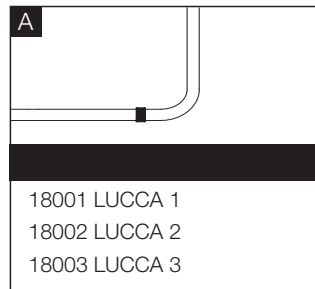





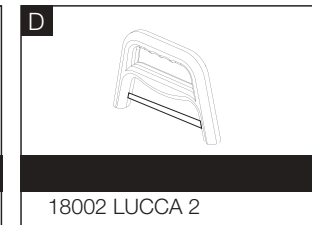
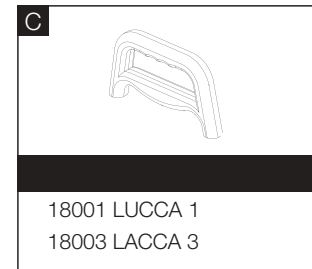
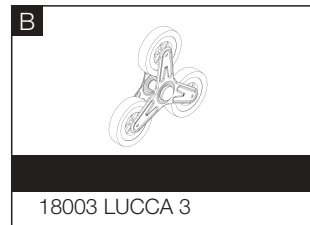
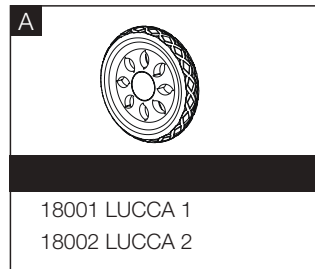













Other

DETAILS



Technical DETAILS

PRODUCT CODE	PRODUCT NAME	 CM	 CM	 CM	 KG	 M ²	 Ø	 PCS	 CM	 M ³	 KG
18502	SUPER MASTER 2	51x80	30x22,5	48x89	3,9	0,02625	20x30-20x20	4	20x90,5x50	0,0905	15,60
18503	SUPER MASTER 3	62x106	30x22,5	48x114,5	5,2	0,02875	20x30-20x20	4	20x115x50	0,115	20,90
18504	SUPER MASTER 4	89x127	30x22,5	48x140	6,775	0,03525	20x30-20x20	4	20x141x50	0,141	27,10

PRODUCT CODE	PRODUCT NAME	 CM	 CM	 KG	 M ²	 Ø	 PCS	 CM	 M ³	 KG
18001	LUCCA 1	36x28x91	91x36x14	1,62	0,0115368	16	10	33x92x38	0,115368	16,2
18002	LUCCA 2	36x28x91	91x36x14	1,62	0,0115368	16	10	33x92x38	0,115368	16,2
18003	LUCCA 3	36x28x91	91x36x14	1,62	0,0115368	16	10	33x92x38	0,115368	16,2

Notes

Notes